

FRILICH

THE ORIGINAL



Katalog Nr. 10 · Catalogue No. 10



Verehrter Kunde,

wir sorgen für den unvergleichlichen und stimmungsvollen Auftritt Ihres Buffets: Die außerordentlich variantenreiche Produktvielfalt an Präsentations- und Spendersystemen, die wir in unserem Frilich Katalog Nr. 10 vorstellen, zeichnet sich durch individuelle Design-Linien aus, die sich jedem Ambiente ohne weiteres anpassen.

Auch eine Vielzahl von Ausstattungsdetails mit dem bewährten, hohen Anspruch an Qualität und Funktion wird Sie überzeugen. FRILICH setzt weiterhin auf den Produktionsstandort Deutschland, um eine lückenlose Qualitätssicherung zu gewährleisten.

Seit nunmehr über 35 Jahren entwickeln und optimieren wir unsere Ideen für den täglichen praktischen Einsatz im permanenten Dialog mit unseren Kunden. Diese Kundennähe hat das familiengeführte Unternehmen FRILICH zum Marktführer und Marktmacher rund ums Buffet gemacht. Wir beraten und unterstützen Sie sehr gern bei der kreativen Buffetgestaltung – rufen Sie uns an!

Dear customer,

We provide for an uncomparable and atmospheric appearance of your buffet: The exceedingly versatile product variety of presentation- and dispensing systems, which we introduce in our Frilich catalogue No. 10, stands out through individual designs suitable to easily adapt to any ambience.

A multitude of equipment details with established high quality and functionality standards will convince you. Frilich furthermore emphasizes on the production site Germany to guarantee a consistent quality assurance.

Since more than 35 years we develop and optimize our ideas for a daily practical use in permanent dialogue with our clients. This customer proximity turned the family-run business FRILICH into a market leader and market shaper for buffet ware. We gladly advise and support you in creating your individual buffet arrangement – just call us!

Stefan Gömmer

Michael Gömmer



Kontakt · Contact

Vertrieb National / Sales Germany



Erika Heer
Fon +49 (0) 64 08 - 90 80 -15
Fax +49 (0) 64 08 - 90 80 -11
e.heer@frilich.de



Gaby Schell
Fon +49 (0) 64 08 - 90 80 -25
Fax +49 (0) 64 08 - 90 80 -11
g.schell@frilich.de



Martin Haese
Fon +49 (0) 64 08 - 90 80 -32
Fax +49 (0) 64 08 - 90 80 -11
m.haese@frilich.de



Ella Flemmer
Fon +49 (0) 64 08 - 90 80 -34
Fax +49 (0) 64 08 - 90 80 -11
e.flemmer@frilich.de



Vera Steinborn
Fon +49 (0) 64 08 - 90 80 -40
Fax +49 (0) 64 08 - 90 80 -11
v.steinborn@frilich.de

Vertrieb International / Sales Worldwide



Sven Schneider
Fon +49 (0) 64 08 - 90 80 -20
Fax +49 (0) 64 08 - 90 80 -44
s.schneider@frilich.de



Ulrike Wagner
Fon +49 (0) 64 08 - 90 80 -28
Fax +49 (0) 64 08 - 90 80 -44
u.wagner@frilich.de

Außendienst / Field Staff Germany



Norbert Hense
Landwehrstraße 1 a
59590 Geseke-Langeneicke
Fon +49 (0) 29 42 - 98 77 29
Fax +49 (0) 29 42 - 98 77 32
n.hense@frilich.de
Vertretungsgebiet:
Westfalen (NRW),
Niedersachsen



Oliver Skokann
Löhfeld 26
21423 Winsen/Luhe
Fon +49 (0) 41 71 - 6 92 33 50
Fax +49 (0) 41 71 - 6 92 33 51
o.skokann@frilich.de
Vertretungsgebiet:
Schleswig-Holstein, Hamburg,
Bremen, Niedersachsen

Pressearbeit / Public Relations



Pressebüro
Elke Baumstark
Postfach 12 19
82168 Puchheim
Büroanschrift:
Sommerstraße 1
82178 Puchheim
Fon +49 (0) 89 - 80 07 18 08
Fax +49 (0) 89 - 80 90 88 19
Baumstark-Foerstl@t-online.de





PAMPA BAY Tisch- und Buffetware
Mit Titan beschichtetes Glas und Porzellan,
nicht nur ganz exklusiv sondern auch robust!

PAMPA BAY Table and Buffet Ware
With titanium coated glass and porcelain,
not only very exclusive but also unexpected
durable!



BOX 'Bread' und 'Bits and Pieces'
Backwaren und kleine Utensilien für die
Gastronomie in der Schublade versteckt
aber doch offen und hygienisch präsentiert.

BOX 'Bread' and 'Bits and Pieces'
Baked goods and small utensils for the
catering hidden in the drawer but still
openly and hygienic presented.



RAISER Buffet System 'OAK'
Flexibel und platzsparend bieten die hoch-
wertig gefertigten Buffetmodule aus Eiche
der gewohnten FRILICH Funktionalität ein
neues, anspruchvolles Gesicht.

RAISER Buffet System, 'OAK',
Flexible and space-saving, the high-quality
oak buffet modules of the familiar FRILICH
functionality offer a new, ambitious look.



ACE OF VASE Getränkespender
Auch große Getränkevolumen können mit
'ACE OF VASE' attraktiv auf dem Buffet
präsentiert werden.

ACE OF VASE Beverage Dispenser
Also large volumes of beverages can be
presented attractively with 'ACE OF VASE'
on the buffet.



RAISER Brain Food Box
Snacks und Fingerfood bei der Kaffeepause, in der Hotel Lobby oder
in Lounges edel und mit System präsentiert.

RAISER Brain Food Box
A noble and organized presentation of snacks and finger food for the
coffee break, in the hotel lobby or in lounges.

Alles für's Buffet / All for Buffet

Ideen für Buffet Stationen	Seite 4
<i>Ideas for Buffet Stations</i>	<i>Page 4</i>
PAMPA BAY	Seite 13
<i>PAMPA BAY</i>	<i>Page 13</i>
Buffets für Getränke	Seite 21
<i>Beverage Buffets</i>	<i>Page 21</i>
Buffets für Müsli, Konfi & Honig	Seite 39
<i>Muesli, Jam & Honey Buffets</i>	<i>Page 39</i>
Buffets für Wurst, Käse, Salate & Joghurt	Seite 51
<i>Cold Cuts, Salad & Yoghurt</i>	<i>Page 51</i>
Schälchenhalter & Hygieneschutz	Seite 77
<i>Bowl Holder & Hygienic Cover</i>	<i>Page 77</i>
Buffets für Brot & Utensilien	Seite 83
<i>Bread Buffets & Utensils</i>	<i>Page 83</i>
Gastro (Displays & Coffee Shop)	Seite 97
<i>Gastro (Displays & Coffee Shop)</i>	<i>Page 97</i>
Accessoires	Seite 102
<i>Accessoires</i>	<i>Page 102</i>
Ersatzteile	Seite 106
<i>Spare Parts</i>	<i>Page 106</i>
FRILICH Buffetplaner	Seite 114
<i>FRILICH Buffet Planer</i>	<i>Page 114</i>
Artikelliste	Seite 116
<i>List of Articles</i>	<i>Page 116</i>
FRILICH Edelstahlhahn	Seite 119
<i>FRILICH Stainless Steel Faucet</i>	<i>Page 119</i>
AGB	Seite 120
<i>Standard Terms</i>	<i>Page 120</i>





CARAFINE, PICKNICK & BUGAMBILIA

- | | |
|---|---|
| 1 LSC 070 H 001 (Seite/page 30) | 5 NFC 030 B 302 (Seite/page 52) |
| 2 LB 609 (Seite/page 30) | 6 NFC 000 B 402 (Seite/page 52) |
| 3 G05.010.0121WW (Bugambilia, Seite/page 6) | 7 3SH010, 3SH014, 3SH012 (Seite/page 103) |
| 4 G06.006.0001 (Bugambilia, Seite/page 8) | 8 3PO054, 3ZU038 (Seite/page 105) |



RAISER 'NATURE'

- | | |
|---------------------------------|--------------------------------|
| 1 RSC 050 H 006 (Seite/page 24) | 4 F09.200.0000 (Seite/page 26) |
| 2 RSC 080 H 006 (Seite/page 24) | 5 RB 648 H 002 (Seite/page 84) |
| 3 F10.201.0000 (Seite/page 27) | 6 3KO020 (Seite/page 106) |



CONNECT, CARAFINE & PAMPA BAY

- | | |
|---------------------------------|--------------------------------|
| 1 ESC 040 E 101 (Seite/page 33) | 5 P01.007.0007 (Seite/page 17) |
| 2 ESC 030 E 101 (Seite/page 33) | 6 P01.007.0008 (Seite/page 17) |
| 3 ESC 060 E 003 (Seite/page 28) | 7 P01.007.0001 (Seite/page 16) |
| 4 P01.007.0003 (Seite/page 16) | 8 3SC330E (Seite/page 103) |



ELEGANCE & PAMPA BAY

- | | |
|---------------------------------|--------------------------------|
| 1 P01.008.0000 (Seite/page 18) | 4 P01.008.0005 (Seite/page 18) |
| 2 EFC 000 G 405 (Seite/page 73) | 5 ESC 025 G (Seite/page 35) |
| 3 P01.008.0002 (Seite/page 18) | 6 3SC330G (Seite/page 103) |



PURE NATURE & CARAFINE

- | | |
|---|-----------------------------------|
| 1 RCO 105 X 002 (Seite/page 48) | 5 RFC 020 X 002 (Seite/page 76) |
| 2 RCO 045 X 002 (Seite/page 48) | 6 RFC 020 X (Seite/page 76) |
| 3 RCO 015 X 002 (Seite/page 48) | 7 3SH011 (Seite/page 103) |
| 4 LSC 030 H 001, 5SC002 (Seite/page 22) | 8 3PO054, 3ZU038 (Seite/page 105) |



ELEGANCE & CONNECT

- | | |
|---------------------------------|---------------------------------|
| 1 EMC 030 E (Seite/page 34) | 5 ETO 015 E 100 (Seite/page 40) |
| 2 ETO 250 E 100 (Seite/page 41) | 6 ETO 006 E 101 (Seite/page 40) |
| 3 ETO 350 E 100 (Seite/page 41) | 7 3SH011 (Seite/page 103) |
| 4 ETO 200 E 100 (Seite/page 40) | 8 3PO054 (Seite/page 105) |



ELEGANCE & PAMPA BAY

- | | |
|---------------------------------|---------------------------------|
| 1 P01.006.0001 (Seite/page 20) | 5 P01.006.0000 (Seite/page 20) |
| 2 EB 616 E 003 (Seite/page 78) | 6 EMC 050 E 007 (Seite/page 37) |
| 3 ECO 018 E (Seite/page 42) | 7 3SH011 (Seite/page 103) |
| 4 ETO 045 E 002 (Seite/page 42) | |



RAISER 'BLACK STEEL' & CONNECT

- | | |
|--------------------------------|---|
| 1 F07.101.0003 (Seite/page 49) | 4 3PO054, 3ZU038 (Seite/page 105) |
| 2 F08.102.0000 (Seite/page 48) | 5 3SH010, 3SH011, 3SH012 (Seite/page 103) |
| 3 3BE007 (Seite/page 28) | |
| EB 801 E (Seite/page 32) | |



PICKNICK & RAISER 'BLACK STEEL'

- 1 NFC 000 B 403, NB 001 E (Seite/page 52)
- 2 NFC 030 B 303, NB 004 E (Seite/page 52)
- 3 F01.102.0000 (Seite/page 57)
- 4 F01.101.0000 (Seite/page 57)
- 5 F02.101.0000 (Seite/page 59)
- 6 F05.101.0004, EB 578 E (Seite/page 65)
- 7 F05.102.0001, EB 578 E (Seite/page 65)
- 8 3PO054, 3ZU038 (Seite/page 105)



PURE NATURE, UNISON & EARTH

- 1 3ST084 (Seite/page 94)
- 2 3ST082 (Seite/page 94)
- 3 EFC 000 E 019 (Seite/page 71)
- 10078 (Seite/page 70)
- 4 NFC 000 E 401, NB 001 E (Seite/page 54)
- 5 EFC 000 E 018 (Seite/page 73)
- EB 543 E (Seite/page 72)
- 6 3SH010, 3SH011, 3SH012 (Seite/page 103)



PURE NATURE & RAISER 'STAINLESS STEEL'

- 1 3ST084 (Seite/page 94)
- 2 3ST162 (Seite/page 94)
- 3 F03.002.0000 (Seite/page 61)
- 4 F01.002.0000 (Seite/page 57)
- 5 EB 710 E (Seite/page 80)



RAISER 'OAK' & BUGAMBILIA

- 1 G05.010.0122WW (Bugambilia Seite/page 6)
- 2 G06.006.0001 (Bugambilia Seite/page 8)
- 3 F01.401.0000 (Seite/page 56)
- 4 F02.400.0000 (Seite/page 58)
- 5 F03.401.0000 (Seite/page 60)
- 6 F03.400.0000 (Seite/page 60)
- 7 F04.401.0000 (Seite/page 62)
- 8 3PO054, 3ZU038 (Seite/page 105)



RAISER 'STAINLESS STEEL' & ELEGANCE

- 1 F13.002.0001 (Seite/page 90)
- 2 F13.000.0001 (Seite/page 90)
- 3 F14.001.0001 (Seite/page 91)
- 4 F03.001.0001 (Seite/page 61)
- 5 F03.002.0001 (Seite/page 61)
- 6 F06.001.0001 (Seite/page 67)
- 7 ETO 000 E 001 (Seite/page 95)



RAISER 'STAINLESS STEEL' & ELEGANCE

- 1 3KO020 (Seite/page 106)
- 2 RB 648 H 002 (Seite/page 84)
- 3 3PO110, 3PO112, 3PO113 (Seite/page 68)
- 4 ETO 000 E 001 (Seite/page 95)
- 5 F06.201.0004 (Seite/page 66)
- 6 F06.200.0001 (Seite/page 66)



RAISER 'OAK' & BOX

- 1 BTO 070 H (Seite/page 86)
- 2 BTO 120 H (Seite/page 86)
- 3 F06.400.0000 (Seite/page 66)
- 4 F06.401.0000 (Seite/page 66)
- 5 ETO 000 E 001 (Seite/page 95)
- 6 RB 648 H 005 (Seite/page 85)
- 7 3KO020 (Seite/page 106)





GASTRO & ELEGANCE

- ❶ ESC 050 E 023 (Seite/page 37) ❸ DB 051, DB 054, 1ME023, 1ME022 (Seite/page 98)
 ❷ DFO 002 A 017* (Seite/page 100) ❹ DB 051, DB 053, 3SA053, 1ME016, 1ME023 (Seite/page 98)



GASTRO & BOX

- ❶ BTO 014 H (Seite/page 86) ❸ DVO 020 H (Seite/page 101)
 ❷ BTO 006 H (Seite/page 86) ❹ DVO 050 H (Seite/page 101)



PAMPA BAY™

PAMPA BAY Produkte werden im Herzen des Pampa-Getreidegürtels in Argentinien entwickelt. Im Umfeld einer atemberaubenden Landschaft arbeiten die Designer ständig an den schönsten Formen, die von diesem Ort inspiriert werden. Pampa Bay bieten unwiderstehliche, einzigartige Designs in bester Qualität, die von den besten Handwerkern der Welt hergestellt werden. Die Hauptstadt Argentiniens, Buenos Aires, ist stark von der europäischen Kultur geprägt und wird häufig als „Paris Südamerikas“ bezeichnet. Jedes Design, das kreiert wird, spiegelt einen Teil dieser Kultur wieder, die elegant und einzigartig ist.

Pampa Bay products are developed in the heart of the Pampa Grain Belt in Argentina. Surrounded by breathtaking scenery, our designers are constantly working on the most beautiful designs inspired by this place. PAMPA BAY offers irresistible, unique, top-quality designs made by the finest craftsmen in the world. The capital of Argentina, Buenos Aires, is strongly influenced by European culture and is often referred to as the „Paris of South America“. Every design created reflects a part of this culture that is elegant and unique.



'When Glass Meets Titanium' Servierschalen und -platten
'When Glass Meets Titanium' Serving Bowls and Platters



P01.005.0000 Dessert-Glasschale mit Titanbeschichtung (blau)
Dessert Glass Bowl with titanium coating (blue)

H: 44 B: 191 T: 191



P01.005.0001 Dessert-Glasschale mit Titanbeschichtung (grün)
Dessert Glass Bowl with titanium coating (green)

H: 44 B: 191 T: 191



P01.005.0002 Dessert-Glasschale mit Titanbeschichtung (braun)
Dessert Glass Bowl with titanium coating (brown)

H: 44 B: 191 T: 191



P01.005.0003 Dessert-Glasschale mit Titanbeschichtung (Champagne)
Dessert Glass Bowl with titanium coating (Champagne)

H: 44 B: 191 T: 191



P01.005.0004 Glasschale, groß mit Titanbeschichtung (blau)
Oversize Glass Bowl with titanium coating (blue)

H:102 B: 343 T: 343



P01.005.0005 Glasschale, groß mit Titanbeschichtung (Champagne)
Oversize Glass Bowl with titanium coating (Champagne)

H:102 B: 343 T: 343



P01.005.0006 Glasschale, klein mit Titanbeschichtung (blau)
Small glass bowl with titanium coating (blue)

H:76 B: 140 T: 140



P01.005.0007 Glasschale, klein mit Titanbeschichtung (Champagne)
Small glass bowl with titanium coating (Champagne)

H:76 B: 140 T: 140



P01.005.0008 Snack-Glasschale mit Titanbeschichtung (blau)
Snack Glass Bowl with titanium coating (blue)

H:64 B: 114 T: 114



P01.005.0009 Snack-Glasschale mit Titanbeschichtung (Champagne)
Snack Glass Bowl with titanium coating (Champagne)

H:64 B: 114 T: 114



P01.005.0010 Snack-Glasschale mit Titanbeschichtung (grün)
Snack Glass Bowl with titanium coating (green)

H:64 B: 114 T: 114



P01.005.0011 Glasschale mit Titanbeschichtung (blau)
Glass Bowl with titanium coating (blue)

H:64 B: 152 T: 152



P01.005.0012 Glasschale mit Titanbeschichtung (Champagne)
Glass Bowl with titanium coating (Champagne)

H:64 B: 152 T: 152



P01.005.0013 Glasschale mit Titanbeschichtung (grün)
Glass Bowl with titanium coating (green)

H:64 B: 152 T: 152

,Verona' Servierschalen und -platten
,Verona' Serving Bowls and Platters



P01.007.0001
Servierschale (flach) mit Titanbeschichtung
Serving bowl (flat) with titanium coating

H: 76 B: 305 T: 229



P01.007.0002
Servierschale (tief) mit Titanbeschichtung
Serving bowl (deep) with titanium coating

H: 102 B: 368 T: 368



P01.007.0003
Ovalplatte (groß) mit Titanbeschichtung
Large oval platter with titanium coating

H: 38 B: 470 T: 330



P01.007.0011
Servierplatte (groß) mit Titanbeschichtung
Serving Platter (large) with titanium coating

H: 38 B: 381 T: 343



P01.007.0000
Serviertablett (rund) mit Titanbeschichtung
Serving Platter (round) with titanium coating

H: 64 B: 356 T: 356



P01.007.0004
Salatschale (groß) mit Titanbeschichtung
Salad bowl (large) with titanium coating

H: 114 B: 267 T: 267

,Verona' Servierschalen und -platten
,Verona' Serving Bowls and Platters



P01.007.0008
Tortenplatte (rund) inkl. Fuß mit Titanbeschichtung
Round Cake Stand incl. Foot with titanium coating

H: 127 B: 279 T: 279



P01.007.0007
Snackschale (groß) mit Titanbeschichtung
Snack bowl (large) with titanium coating

H: 83 B: 222 T: 210



P01.007.0005
Snackschale mit Titanbeschichtung
Cracker Tray with titanium coating

H: 38 B: 356 T: 89



P01.007.0009
Amuse-Gueule-Platte (rund) inkl. Fuß mit Titanbeschichtung
Pedestal Cupcake Stand incl. Foot with titanium coating

H: 76 B: 127 T: 127

P01.007.0010
Snackschale (klein) mit Titanbeschichtung
Snack Bowl with titanium coating

H: 51 B: 140 T: 121



P01.007.0006
Snackplatte (klein) mit Titanbeschichtung
Round appetizer / dessert plate with titanium coating

H: 38 B: 178 T: 178

„Monaco“ Servierschalen und -platten
„Monaco“ Serving Bowls and Platters



P01.008.0001 Servierschale (flach) mit Titanbeschichtung
Serving bowl (flat) with titanium coating

H: 76 B: 305 T: 229



P01.008.0002

Ovalplatte (groß) mit Titanbeschichtung
Large oval platter with titanium coating

H: 38 B: 470 T: 330



P01.008.0004 Salatschale mit Titanbeschichtung
Salad Bowl with titanium coating

H: 89 B: 216 T: 216



P01.008.0006 Snackschale (klein) mit Titanbeschichtung
Snack bowl with titanium coating

H: 51 B: 121 T: 140



P01.008.0000 Serviertablett (rund) mit Titanbeschichtung
Serving Platter (round) with titanium coating

H: 64 B: 356 T: 356

P01.008.0003 Snackschale mit Titanbeschichtung
Cracker Tray with titanium coating

H: 38 B: 356 T: 89



P01.008.0005 Amuse-Gueule-Platte (rund) mit Titanbeschichtung
Pedestal cupcake stand with titanium coating

H: 76 B: 127 T: 127



„Golden Salerno“ Servierschalen und -platten
„Golden Salerno“ Serving Bowls and Platters



P01.009.0000 Salatschale (groß) mit Titanbeschichtung
Salad Bowl (large) with titanium coating

H: 127 B: 267 T: 267



P01.009.0001 Snackschale mit Titanbeschichtung
Cracker Tray with titanium coating

H: 38 B: 356 T: 89



IT'S PORCELAIN.

High fired porcelain serveware. / Hoch gebranntes Porzellan.
Gold and silver titanium finish. / Gold- bzw. Silberausführung mit Titanbeschichtung.
Dishwasher safe. / Spülmaschinengeeignet.
Stain resistant. / Beständigkeit gegen Fleckenbildung.
Food safe / Lebensmittelecht.
Will not scratch or lose luster. / keine Bildung von Kratzer und verliert nicht an Glanz.
Tarnish free. / Läuft nicht an.
Oven safe up to 350 F. / Verwendung im Backofen bis zu 175 C.

THE LOOK OF METAL WITH THE CONVENIENCE OF PORCELAIN.

„Salerno“ Servierschalen und -platten
„Salerno“ Serving Bowls and Platters



P01.006.0000
 Ovalplatte (groß) mit
 Titanbeschichtung
*Oval platter (large) with
 titanium coating*

H: 38 B: 470 T: 330

P01.006.0001
 Salatschale (groß) mit
 Titanbeschichtung
*Salad bowl (large) with
 titanium coating*

H: 114 B: 267 T: 254



P01.006.0005
 Snackschale (klein) mit
 Titanbeschichtung
*Snack bowl (small) with
 titanium coating*

H: 51 B: 140 T: 121



P01.006.0002
 Snackschale mit
 Titanbeschichtung
*Cracker Tray with
 titanium coating*

H: 38 B: 356 T: 89



P01.006.0003
 Tortenplatte (rund) inkl. Fuß
 mit Titanbeschichtung
*White pedestal cupcake stand (round)
 with titanium coating*

H: 127 B: 279 T: 279



P01.006.0004
 Amuse-Gueule-Platte
 inkl. Fuß mit Titanbeschichtung
*Round cake stand with
 titanium coating*

H: 76 B: 127 T: 127



GETRÄNKE / BEVERAGES

FRILICH bietet ein sehr variantenreiches Programm, um Saft und Milch auf dem Buffet für jeden Geschmack, richtig in Szene zu setzen. Ob in der Karaffe oder im klassischen Dispenser, die Produktverarbeitung ist unvergleichbar, der Zapfhahn für die Dispenser ist einzigartig. Nur der Edelstahlhahn von FRILICH ist für nahezu alle Getränke einsetzbar, formschön und zugleich einfach zu reinigen.

FRILICH offers a very varied range to present juice and milk on the buffet for every taste. Whether in the carafe or in a classic dispenser, the quality of the products are incomparable, the dispensing faucet is unique. Only the stainless steel faucet by FRILICH can be used for almost all beverages, attractive and easy to clean at the same time.

CARAFINE Getränke-Set 'Trio Timber'
CARAFINE Beverage-Set 'Trio Timber'



'Natur'
 Holztragerl (natur), 3 Kunststoffeinsätze
 sowie Halterung für Kühlakkus, 3 Kühlakkus,
 3 Glasflaschen mit Milchmotiv (á 1,0 l)
*Wooden Crate (nature), 3 Plastic Insets and
 Cooling Pack Holder, 3 Cooling Packs, 3 Glass
 Bottles with Milk Motif (1,0 l ea.)*

LSC 030 H 001

Maße / Dimensions:
 ☰ 445 ☱ 410 ☲ 170



'Vintage White'
 Holztragerl (mit weißem Lack in 'used look'
 bearbeitet), 3 Kunststoffeinsätze sowie Halte-
 rung für Kühlakkus, 3 Kühlakkus, 3 Glasflaschen
 mit Milchmotiv (á 1,0 l)
*Wooden Crate 'Vintage White' (processed with
 white varnish in 'used look'), 3 Plastic Insets and
 Cooling Pack Holder, 3 Cooling Packs, 3 Glass
 Bottles with Milk Motif (1,0 l ea.)*

LSC 030 H 003

Maße / Dimensions:
 ☰ 445 ☱ 410 ☲ 170



Holztragerl 'Natur'
 inkl. 3 Kunststoffeinsätze
 sowie Halterungen für Kühlakkus,
 3 Kühlakkus
Wooden Crate 'Nature'
*incl. 3 Plastic Insets and Cooling Pack
 Holder, 3 Cooling Packs*
LB 607



Holztragerl 'Vintage White'
 mit weißem Lack in 'used look'
 bearbeitet, inkl. 3 Kunststoffeinsätze
 sowie Halterungen für Kühlakkus,
 3 Kühlakkus
Wooden Crate 'Vintage White'
*processed with white varnish in 'used look'
 incl. 3 Plastic Insets and Cooling Pack
 Holder, 3 Cooling Packs*
LB 608



Flasche mit Milchmotiv (1,0 l)
 und Silikonstopfen
Bottle with milk motif (1,0 l)
 and Silicon Plug
LB 506



Steckschild aus Holz (natur)
 mit individueller Beschriftung
Insert Wooden Label (nature)
Inscription of Choice
SSC002

! Steckschilder mit individueller Beschriftung separat bestellen
 Insert Label with individual Inscription of choice has to be ordered separately



! Auch Karaffen und Bügelflaschen einsetzbar Seite 30
 Also applicable for Carafes and Swing Top Bottles Page 30

ACE OF VASE Saftkanne 'Uno'
ACE OF VASE Juice Dispenser 'Uno'



mit Kunststoffbehälter 12 Liter (PC),
 FRILICH Zapfhahn-Adapter, Edelstahlhahn,
 Standfuss aus Multiplexholz,
 Edelstahldeckel für Eiswürfel-Kühlung und /oder
 Obst-Dekoration, Kühlakku, Tropfschale
*with plastic container 12 liters (PC),
 FRILICH Faucet Adapter,
 Stainless Steel Faucet,
 Stand made of multiplex wood,
 Stainless Steel lid for ice cube
 Cooling and /or fruit decoration,
 Cooling Pack, Drip Tray*

ASC 100 H

Maße / Dimensions:
 ☰ 810 ☱ 330 ☲ 200



ACE OF VASE Saftkanne 'Duo'
ACE OF VASE Juice Dispenser 'Duo'



mit Kunststoffbehältern 2x 12 Liter (PC),
 FRILICH Zapfhahn-Adapter, Edelstahlhahn,
 Standfuss aus Multiplexholz,
 Edelstahldeckel für Eiswürfel-Kühlung und /oder
 Obst-Dekoration, Kühlakku, Tropfschale
*with plastic container 2x 12 liters (PC), FRILICH
 Faucet Adapter, Stainless Steel Faucet, Stand
 made of multiplex wood,
 Stainless Steel lid for ice cube
 Cooling and /or fruit decoration,
 Cooling Pack, Drip Tray*

ASC 200 H

Maße / Dimensions:
 ☰ 810 ☱ 530 ☲ 200

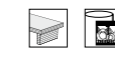

PURE NATURE Milchkanne
PURE NATURE Milk Can



Buche, natur
 Crasheisröhre und Kühlakku inkl. Tropfschale
 und Edelstahlhahn
*Natural Beech, crushed ice tube, cooling pack
 incl. drip tray and Stainless Steel Faucet*

3 Liter / 3 liters

RMC 030 X 004

Maße / Dimensions:
 ☰ 383 ☱ 225 ☲ 220

5 Liter / 5 liters

RMC 050 X

Maße / Dimensions:
 ☰ 415 ☱ 225 ☲ 220



Nachschubbehälter (12 Liter)
 inkl. Edelstahlhahn, FRILICH Zapf-
 hahn-Adapter und Edelstahldeckel
 für Eiswürfelkühlung und
 Obst-Dekoration
*Spare Container (12 liters)
 Incl. stainless steel Faucet,
 FRILICH Faucet Adapter and
 Stainless Steel Lid for ice cube
 cooling and Fruit Decoration*
AB 100 E



Nachschubbehälter (3 Liter)
 inkl. Crasheisröhre
*Spare Container (3 liters)
 incl. crushed ice tube*
EB 565 E



Nachschubbehälter (5 Liter)
 inkl. Crasheisröhre
*Spare Container (5 liters)
 incl. crushed ice tube*
EB 564 E

RAISER Getränke-Set 'Barrel'
RAISER Beverage-Set 'Barrel'

RAISER Getränke-Set 'Barrel Individual'
RAISER Beverage-Set 'Barrel Individual'



Standfuß-Rahmen aus Holz, Dekor-Edelstahlplatte, Kühlkissen, Tropfschale, Glasbehälter mit Universaladapter und Edelstahlhahn.
Wooden Stand, Decore Stainless Steel Frame, Cooling Cushion, Drip Tray, Glass Barrel with Universal Adapter and Stainless Steel Faucet.

Barrel 'Vintage white'

Standfuß-Rahmen aus Fichte mit weißem Lack bearbeitet in 'used look'
Wooden Stand made of spruce in white varnish in 'used look'

5 Liter
RSC 050 H 004

Maße / Dimensions: 470 x 230 x 315

8 Liter
RSC 080 H 004

Maße / Dimensions: 525 x 230 x 330



Standfußrahmen aus Fichte 'Vintage white' mit weißem Lack in 'used look' inkl. Eiseinsatz und Kühlkissen, Dekor-Edelstahlplatte
Wooden-Stand made of spruce with white varnish in 'used look' incl. Ice Insert and Cooling Cushion, Decore Frame, Stainless Steel

RB 643 H 002

Maße / Dimensions: 200 x 228 x 228



Standfußrahmen aus Fichte, natur inkl. Eiseinsatz und Kühlkissen, Dekor-Edelstahlplatte
Wooden-Stand made of spruce incl. Ice Insert and Cooling Cushion, Decore Frame, Stainless Steel

RB 643 H 003

Maße / Dimensions: 200 x 251 x 251



Standfußrahmen aus Eiche inkl. Eiseinsatz und Kühlkissen, Dekor-Edelstahlplatte
Wooden-Stand made of spruce incl. Ice Insert and Cooling Cushion, Decore Frame, Stainless Steel

RB 643 H 006

Maße / Dimensions: 198 x 251 x 251



5 L



8 L

Glasbehälter mit Bügelverschluss, Universal-Adapter und Edelstahlhahn
Glass Container with Flip-Top Lid, Universal Adapter and Stainless Steel Faucet

Glasbehälter 'Barrel Classic'
Glass Container 'Barrel Classic'
5 Liter / 5 liters

RB 710 X 001

Maße / Dimensions:
305 x 185 x 290

8 Liter / 8 liters

RB 711 X 001

Maße / Dimensions:
360 x 210 x 315



Standfuß-Set 'Barrel Individual'
Base-Set 'Barrel Individual'

Dekorplatten zur individuellen Gestaltung des Unterbaus
Decore Discs for an individual Platform Setup



7 Scheiben / Discs (Ø 240 mm x 30)
7 Scheiben / Discs (Ø 100 mm x 10)
Birke (natur) / Birch, nature

NB 008 H



7 Scheiben / Discs (Ø 240 mm x 30)
Travertin (Kalkstein) / Travertin (Limestone)

NB 008 R 001



Barrel 'Nature'

Standfuß-Rahmen aus Fichte, natur.
Wooden Stand made of spruce (bright).

5 Liter
RSC 050 H 006

Maße / Dimensions: 470 x 230 x 315

8 Liter
RSC 080 H 006

Maße / Dimensions: 533 x 251 x 360



Barrel 'Oak'

Standfuß-Rahmen aus Eiche, natur.
Wooden Stand made of oak.

5 Liter
RSC 050 H 008

Maße / Dimensions: 478 x 251 x 360

8 Liter
RSC 080 H 008

Maße / Dimensions: 525 x 230 x 330



Optional/optional



Crasheisröhre
aus Acrylglas
Crushed Ice Tube
made of acrylic glass

für 5 Liter / for 5 liters
8PL013

für 8 Liter / for 8 liters
8PL012



Aufgussröhre
aus Acrylglas
Infusion Tube
made of acrylic glass

für 5 Liter / for 5 liters
8PL014

für 8 Liter / for 8 liters
8PL011

Accessoire:



Tropfschale
mit Tropfgitter
aus Edelstahl
Drip Dish with Drip Grill
made of Stainless Steel

RB 907 E



Anwendungsbeispiele / Examples of use



RAISER Getränke-Set '33 x 33'
RAISER Beverage-Set '33 x 33'



Edelstahlschale inkl. drei Kühlrippen*, mit 20 Bügelflaschen (à 0,2 Liter) auf Standfussrahmen aus Eichenholz
Stainless steel tray incl. three cooling fins*, with 20 Swing Top Bottles (à 0,2 liters) on Oak Base Frame

Maße / Dimensions:

H 352 L 352

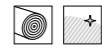

Standfuss L
F09.400.0000

€ 360

Standfuss S
F09.401.0000

€ 264

RAISER Getränke-Set '23 x 23'
RAISER Beverage-Set '23 x 23'



Edelstahlschale inkl. zwei Kühlrippen*, mit 9 Bügelflaschen (à 0,2 Liter) auf Standfussrahmen aus Eichenholz
Stainless steel tray incl. two cooling fins*, with 9 Swing Top Bottles (à 0,2 liters) on Oak Base Frame

Maße / Dimensions:

H 252 L 252



Standfuss L
F10.400.0000

L: € 365



Standfuss S
F10.401.0000

€ 271



Edelstahlschale inkl. drei Kühlrippen*, mit 20 Bügelflaschen (à 0,2 Liter) auf Standfussrahmen aus Fichtenholz, natur
Stainless steel tray incl. three cooling fins*, with 20 Swing Top Bottles (à 0,2 liters) on Spruce Base Frame

Maße / Dimensions:

H 327 L 327



Standfuss L
F09.200.0000

€ 360

Standfuss M:
F09.201.0000

€ 294



Edelstahlschale inkl. zwei Kühlrippen*, mit 9 Bügelflaschen (à 0,2 Liter) auf Standfussrahmen aus Fichtenholz, natur
Stainless steel tray incl. two cooling fins*, with 9 Swing Top Bottles (à 0,2 liters) on Spruce Base Frame

Maße / Dimensions:

H 228 L 228



Standfuss L
F10.200.0000

€ 366



Standfuss M:
F10.201.0000

€ 301



Edelstahlschale inkl. drei Kühlrippen*, mit 20 Bügelflaschen (à 0,2 Liter) auf Standfussrahmen aus Fichtenholz, weiß lackiert in 'used look'
Stainless steel tray incl. three cooling fins*, with 20 Swing Top Bottles (à 0,2 liters) on Spruce Base Frame, white varnish in 'Used Look'

Maße / Dimensions:

H 327 L 327



Standfuss L
F09.300.0000

€ 360

Standfuss M:
F09.301.0000

€ 294



Edelstahlschale inkl. zwei Kühlrippen*, mit 9 Bügelflaschen (à 0,2 Liter) auf Standfussrahmen aus Fichtenholz, weiß lackiert in 'used look'
Stainless steel tray incl. two cooling fins*, with 9 Swing Top Bottles (à 0,2 liters) on Spruce Base Frame, white varnish in 'Used Look'

Maße / Dimensions:

H 228 L 228



Standfuss L
F10.300.0000

L: € 366



Standfuss M:
RF10.301.0000

€ 301



Edelstahlschale inkl. drei Kühlrippen*, mit 20 Bügelflaschen (à 0,2 Liter) auf Edelstahlstandfussrahmen
Stainless steel tray incl. three cooling fins*, with 20 Swing Top Bottles (à 0,2 liters) on Stainless Steel Base Frame

Maße / Dimensions:

H 311 L 311



Standfuss L
F09.000.0000

€ 348

Standfuss M:
F09.001.0000

€ 298

Standfuss S
F09.002.0000

€ 248



Edelstahlschale inkl. zwei Kühlrippen*, mit 9 Bügelflaschen (à 0,2 Liter) auf Edelstahlstandfussrahmen
Stainless steel tray incl. two cooling fins*, with 9 Swing Top Bottles (à 0,2 liters) on Stainless Steel Base Frame

Maße / Dimensions:

H 211 L 211



Standfuss L
F10.000.0000

L: € 330



Standfuss M:
F10.001.0000

€ 280



Standfuss S
F10.002.0000

€ 230



Edelstahlschale inkl. drei Kühlrippen*, mit 20 Bügelflaschen (à 0,2 Liter) auf schwarzem Metallstandfussrahmen
Stainless steel tray incl. three cooling fins*, with 20 Swing Top Bottles (à 0,2 liters) on Black Steel Base Frame

Maße / Dimensions:

H 335 L 335



Standfuss L
F09.100.0000

€ 350

Standfuss M:
F09.101.0000

€ 300

Standfuss S
F09.102.0000

€ 250



Edelstahlschale inkl. zwei Kühlrippen*, mit 9 Bügelflaschen (à 0,2 Liter) auf schwarzem Metallstandfussrahmen
Stainless steel tray incl. two cooling fins*, with 9 Swing Top Bottles (à 0,2 liters) on Black Steel Base Frame

Maße / Dimensions:

H 236 L 236



Standfuss L
F10.100.0000

€ 332



Standfuss M:
F10.101.0000

€ 282



Standfuss S
F10.102.0000

€ 232

CARAFINE Getränke-Set 'Quintet'
CARAFINE Beverage Set 'Quintet'



Edelstahlkugel, doppelwandig mit Isolierung,
 Edelstahl-Crasheisröhre zum Einstellen
*Double Wall Stainless Steel Bowl
 with stainless steel crushed ice tube in center*

'Poliert' mit 5 Glaskaraffen
 (à 1,2 l) inkl. Edelstahldeckel
*'Polished' with 5 Glass Carafes
 (1.2 l ea.) with stainless steel lids*
 ESC 060 E

'Poliert' mit 5 Kunststoffkaraffen
 (à 1,2 l) inkl. Edelstahldeckel
*'Polished' with 5 Plastic Carafes
 (1.2 l ea.) with stainless steel lids*
 ESC 060 E 001

Maße / Dimensions:
 Ø 350 H 330



'Hammered' mit 5 Glaskaraffen
 (à 1,2 l) inkl. Edelstahldeckel
*'Hammered' with 5 Glass Carafes
 (1.2 l ea.) with stainless steel lids*
 ESC 060 E 002

'Hammered' mit 5 Kunststoffkaraffen
 (à 1,2 l) inkl. Edelstahldeckel
*'Hammered' with 5 Plastic Carafes
 (1.2 l ea.) with stainless steel lids*
 ESC 060 E 003

Maße / Dimensions:
 Ø 350 H 330

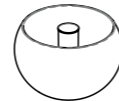

Edelstahlkugel, doppelwandig
 mit Isolierung, Edelstahl-Crasheis-
 röhre zum Einstellen
*Double Wall Stainless Steel Bowl,
 with stainless steel crushed ice tube
 in center*

'Poliert' / 'Polished'
 3BE005

'Hammered' / 'Hammered'
 3BE015

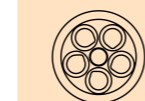

Draufsicht / Topview



CARAFINE Getränke-Set 'Triplet'
CARAFINE Beverage Set 'Triplet'



Edelstahlkugel, doppelwandig mit Isolierung,
 Edelstahl-Crasheisröhre zum Einstellen
*Double Wall Stainless Steel Bowl
 with stainless steel crushed ice tube in center*

'Poliert' mit 3 Glaskaraffen
 (à 1,2 l) inkl. Edelstahldeckel
*'Polished' with 3 Glass Carafes
 (1.2 l ea.) with stainless steel lids*
 ESC 036 E

'Poliert' mit 3 Kunststoffkaraffen
 (à 1,2 l) inkl. Edelstahldeckel
*'Polished' with 3 Plastic Carafes
 (1.2 l ea.) with stainless steel lids*
 ESC 036 E 001

Maße / Dimensions:
 Ø 320 H 330



'Hammered' mit 3 Glaskaraffen
 (à 1,2 l) inkl. Edelstahldeckel
*'Hammered' with 3 Glass Carafes
 (1.2 l ea.) with stainless steel lids*
 ESC 036 E 002

'Hammered' mit 3 Kunststoffkaraffen
 (à 1,2 l) inkl. Edelstahldeckel
*'Hammered' with 3 Plastic Carafes
 (1.2 l ea.) with stainless steel lids*
 ESC 036 E 003

Maße / Dimensions:
 Ø 320 H 330

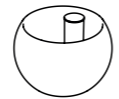

Edelstahlkugel, doppelwandig
 mit Isolierung, Edelstahl-Crasheis-
 röhre zum Einstellen
*Double Wall Stainless Steel Bowl,
 with stainless steel crushed ice tube
 in center*

'Poliert' / 'Polished'
 3BE007

'Hammered' / 'Hammered'
 3BE017



Draufsicht / Topview



CARAFINE Getränke-Set 'Solo'
CARAFINE Beverage Set 'Solo'



Inhalt: 1,2 Liter / Content: 1.2 liters
 Isolierter Standfuß mit 3 Kühlakkus im Edelstahlmantel
Insulated Base including 3 cooling packs and stainless steel shell

'Poliert' mit Kunststoffkaraffe (1,2 l)
 inkl. Edelstahldeckel
*'Polished' with Plastic Carafe (1.2 l)
 incl. Stainless Steel Lid*

Edelstahl / Stainless Steel
 ESC 012 E 002

Gold (24 Karat hartvergoldet)
Gold (24-carat gold plated)
 ESC 012 G 001

Maße / Dimensions: Ø 165 H 310



Standfuß separat bestellen? Seite 108
Base ordered separately? Page 108

'Poliert' mit Glaskaraffe (1,2 l)
 inkl. Edelstahldeckel
*'Polished' with Glass Carafe (1.2 l)
 incl. Stainless Steel Lid*

Edelstahl / Stainless Steel
 ESC 012 E.

Gold (24 Karat hartvergoldet)
Gold (24-carat gold plated)
 ESC 012 G





CARAFINE Getränke-Set 'Septet'
CARAFINE Beverage-Set 'Septet'



'Natur'
Holzfass (Robinienholz natur), Rahmeneinsatz für Flaschen (verchromt), Kunststoffeinsatz (transparent) zur Aufnahme von Crasheis oder Eiswürfel, sieben Bügelflaschen (à 1,0 l)
Wooden Bucket (black locust wood, nature), Support Frame for Bottles (chromium plated), Plastic Inset (transparent) for holding crushed ice or ice cubes, seven Swing Top Bottles (1,0 l ea.)
LSC 070 H 001

Maße / Dimensions:
Ø 400 H 363



'Vintage White'
Holzfass (Robinienholz) mit weißem Lack bearbeitet in 'used look', Rahmeneinsatz für Flaschen (verchromt), Kunststoffeinsatz (transparent) zur Aufnahme von Crasheis oder Eiswürfel, sieben Bügelflaschen (à 1,0 l)
Wooden Bucket (black locust wood), processed with white varnish in used look, Support Frame for Bottles (chromium plated) Plastic Inset (transparent) for holding crushed ice or ice cubes, seven Swing Top Bottles (1,0 l ea.)
LSC 070 H 002

Maße / Dimensions:
Ø 400 H 363



Holzfass 'Septet Natur'
inkl. Rahmeneinsatz und Kunststoffeinsatz
Wooden Bucket 'Septet Nature'
incl. Support Frame and Plastic Inset
LB 605



Holzfass 'Septet Vintage White'
inkl. Rahmeneinsatz und Kunststoffeinsatz
Wooden Bucket 'Septet Vintage'
incl. Support Frame and Plastic Inset
LB 606



Bügelflasche (1,0 l)
Swing Top Bottle (1,0 l)
3GL021



Kettenschild aus Holz
mit individueller Beschriftung
Label Chain (wood),
Inscription of Choice
5SC001

Optional / Optional



Glaskaraffe
mit Edelstahldeckel (1,2 l)
Glass Carafe with St. St. Lid (1,2 l)
EB 581 E



Kunststoffkaraffe
mit Edelstahldeckel (1,2 l)
Plastic Carafe with St. St. Lid (1,2 l)
EB 802 E



Flasche mit Milchmotiv
(1,0 l)
und Silikonstopfen
Bottle with milk motif (1,0 l)
and Silicon Plug
LB 506



Ohne Flasche
Without bottle



CARAFINE Getränke-Set 'Solo'
CARAFINE Beverage-Set 'Solo'

'Natur'
Holzfass (Robinienholz natur), Kunststoffeinsatz (transparent) zur Aufnahme von Crasheis oder Eiswürfeln. Einstellen von FRILICH Flaschen, Karaffen bzw. Sekt- oder Champagnerflaschen
Wooden Bucket (black locust wood nature), Plastic Inset (transparent) for holding crushed ice or ice cubes. Display for FRILICH bottles, carafes or Champagne bottles
LB 609

Maße / Dimensions: Ø 230 H 180

'Vintage White'
Holzfass (Robinienholz) mit weißem Lack in 'used look' bearbeitet, Kunststoffeinsatz (transparent) zur Aufnahme von Crasheis oder Eiswürfeln. Einstellen von FRILICH Flaschen, Karaffen bzw. Sekt- oder Champagnerflaschen
Wooden Bucket (black locust wood), processed with white varnish in used look, Plastic Inset (transparent) for holding crushed ice or ice cubes. Display for FRILICH bottles, carafes or Champagne bottles
LB 610

Maße / Dimensions: Ø 230 H 180



CARAFINE Getränke-Set 'Crystal'
CARAFINE Beverage-Set 'Crystal'

Inhalt: 1,2 Liter / *Content: 1.2 liters*
Standfuß und Standfußhaube aus spülmaschinengeeignetem Kunststoff (klar), Kunststoffkaraffe mit Edelstahldeckel, Edelstahl-Tropfschale
Base and Base Hood made of dishwasher proof plastic (light), Plastic Carafe with Stainless Steel Lid, Stainless Steel Drip Tray

ESC 012 E 001

Maße / Dimensions:
Ø 220 H 295



Kunststoffkaraffe
mit Edelstahldeckel (1,2 l)
Plastic Carafe with St. St. Lid (1,2 l)
EB 802 E



Standfußbehälter
Kunststoff für Crasheis bzw. Eiswürfel und Karaffe
Plastic Base Reservoir for crushed ice or ice cubes and carafe
3BE010

ELEGANCE Saftkanne 'Twin'
ELEGANCE Juice Dispenser 'Twin'

Doppelte Präsentation von Säften im 4 und 5 Liter Behälter. Doppelte Kühlung durch Edelstahl-Crasheisröhre und Kühlakku im Standfuß.
Double presentation of juices in 4 and 5 liter dispensers. Double cooling by stainless steel crushed ice tube and cooling pack in the base.

ESC 090 E
mit Edelstahlhahn
mit Behälter 4 und 5 Liter
with Stainless Steel Faucet with container 4 and 5 liters

ESC 090 E 800
mit Non-Drip-Hahn
mit Behälter 4 und 5 Liter,
with Non-Drip-Faucet with container 4 and 5 liters

Maße / Dimensions:
☰ 490 ☨ 355 ☩ 370



Edelstahlhahn
Stainless Steel Faucet

Non-Drip-Hahn
Non-Drip-Faucet

CONNECT Saftkanne 'Juicer'
CONNECT Juice Dispenser 'Juicer'

Saftkanne aus Edelstahl, Acrylglasbehälter, Kühlakku im Standfuß sowie in der Deckelschale, inkl. Standfuß Modell 'Edelstahl' und Tropfschale sowie Edelstahlhahn Juice Dispenser st. st., acrylic container, cooling pack in the base and in the small bowl below the lid, incl. base modul 'Stainless Steel' and drip tray as well as St. St. Faucet

3 Liter / 3 liters:
ESC 030 E 101
Maße / Dimensions:
☰ 685 ☨ 170 ☩ 190

4 Liter / 4 liters:
ESC 040 E 101
Maße / Dimensions:
☰ 825 ☨ 170 ☩ 190



CONNECT Getränke-Set 'Carafine'
CONNECT Beverage-Set 'Carafine'

Karaffe 1,2 Liter, zur Präsentation von Milch, Säften und Wasser, mit Edelstahldeckel inkl. Standfuß Modell 'Edelstahl'
Carafe 1.2 liters, for beverage presentation (milk, juice, water etc.), with st. st. lid incl. base model 'Stainless Steel'

mit Glaskaraffe / *with Glass Carafe*

ESC 012 E 100

mit Kunststoffkaraffe, spülmaschineneeignet
with Plastic Carafe, dishwasher proof

ESC 012 E 101

mit Porzellankaraffe / *with China Carafe*

EMC 012 E 100

Maße / Dimensions: ☰ 300 ☨ 170 ☩ 154



Glaskaraffe (1,2 Liter)
inkl. Edelstahldeckel
Glass Carafe (1.2 liters)
incl. Stainless Steel Lid
EB 581 E

Kunststoffkaraffe (1,2 Liter)
spülmaschineneeignet,
inkl. Edelstahldeckel
Plastic Carafe (1.2 liters),
dishwasher proof,
incl. Stainless Steel Lid
EB 802 E

Porzellankaraffe (1,2 Liter)
inkl. Edelstahldeckel
China Carafe (1.2 liters)
incl. Stainless Steel Lid
EB 801 E

Standfuß Modell 'Edelstahl'
Base Model 'Stainless Steel'
EB 634 E

Nachschubbehälter / *Spare Container*

'Juicer' Modul (3 Liter)
Edelstahlfuß mit Acryl-Kunststoff-behälter, Kühlakku, Edelstahldeckel und Edelstahlhahn
'Juicer' Module (3 liters)
St. st. base with acrylic container, cooling pack, st. st. lid and st. st. faucet
EB 712 E 001

'Juicer' Modul (4 Liter)
Edelstahlfuß mit Acryl-Kunststoff-behälter, Kühlakku, Edelstahldeckel und Edelstahlhahn
'Juicer' Module (4 liters)
St. st. base with acrylic container, cooling pack, st. st. lid and st. st. faucet
EB 713 E 001

Optional / *optional*

Standfuß Modell 'Edelstahl'
Base Model 'Stainless Steel'
EB 634 E

Reinigungsbürste
Cleaning Brush
3ZU026



**ELEGANCE Saftkanne**
ELEGANCE Juice Dispenser

Saftzylinder aus spülmaschinengeeignetem Kunststoff, Kühlakku im Standfuß sowie Edelstahl-Crasheisröhre, Edelstahltropfschale und Edelstahlhahn
Juice Container made of dishwasher proofed plastic, cooling pack in base, st. st. crushed ice tube, st. st. drip tray and st. st. faucet

5 Liter / 5 Liters**Edelstahl / Stainless Steel****ESC 050 E** mit transparentem Zylinder
*with transparent container***ESC 050 E 900** mit Zylinder opal
*with translucent container***Maße / Dimensions:**

☒ 490 ☒ 235 ☒ 370

**Nachschubbehälter (5 Liter)**
inkl. Crasheisröhre und Edelstahlhahn
Spare Container (5 liters)
*incl. crushed ice tube and Stainless Steel Faucet***EB 502 E** (transparent)**EB 502 E 900** (opal/translucent)**Nachschubbehälter (2,5 Liter)**
inkl. Crasheisröhre und Edelstahlhahn
Spare Container (2.5 liters)
*incl. crushed ice tube and Stainless Steel Faucet***EB 562 E** (transparent)**EB 562 E 900** (opal/translucent)**2,5 Liter / 2,5 Liters****Edelstahl / Stainless Steel****ESC 025 E** mit transparentem Zylinder
*with transparent container***ESC 025 E 900** mit Zylinder opal
*with translucent container***Maße / Dimensions:**

☒ 435 ☒ 205 ☒ 336

**ELEGANCE Saftkanne**
ELEGANCE Juice Dispenser

Saftzylinder aus spülmaschinengeeignetem Kunststoff, Kühlakku im Standfuß sowie Edelstahl-Crasheisröhre, Edelstahltropfschale und Edelstahlhahn
Juice Container made of dishwasher proofed plastic, cooling pack in base, st. st. crushed ice tube, st. st. drip tray and st. st. faucet

5 Liter / 5 Liters**Gold (24 Karat hartvergoldet)**
*Gold (24-carat gold plated)***ESC 050 G** mit transparentem Zylinder
*with transparent container***ESC 050 G 900** mit Zylinder opal
*with translucent container***Maße / Dimensions:**

☒ 490 ☒ 235 ☒ 370

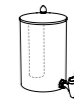
**Nachschubbehälter (5 Liter)**
inkl. Crasheisröhre und Edelstahlhahn
Spare Container (5 liters)
*incl. crushed ice tube and Stainless Steel Faucet***EB 502 G** (transparent)**EB 502 G 900** (opal/translucent)**Nachschubbehälter (2,5 Liter)**
inkl. Crasheisröhre und Edelstahlhahn
Spare Container (2.5 liters)
*incl. crushed ice tube and Stainless Steel Faucet***EB 562 G** (transparent)**EB 562 G 900** (opal/translucent)**2,5 Liter / 2,5 Liters****Gold (24 Karat hartvergoldet)**
*Gold (24-carat gold plated)***ESC 025 G** mit transparentem Zylinder
*with transparent container***ESC 025 G 900** mit Zylinder opal
*with translucent container***Maße / Dimensions:**

☒ 435 ☒ 205 ☒ 336

**ELEGANCE Milchkanne**
ELEGANCE Milk Can

Milchbehälter aus Edelstahl, Kühlakku im Standfuß sowie Edelstahl-Crasheisröhre, Edelstahltropfschale und Edelstahlhahn
Milk Container made of Stainless Steel, cooling pack in base, st. st. crushed ice tube, st. st. drip tray and st. st. faucet

3 Liter / 3 Liters**Edelstahl / Stainless Steel****EMC 030 E****Gold (24 Karat hartvergoldet)**
*Gold (24-carat gold plated)***EMC 030 G****Maße / Dimensions:**

☒ 400 ☒ 205 ☒ 336

**Nachschubbehälter (3 Liter)**
inkl. Crasheisröhre und Edelstahlhahn
Spare Container (3 liters)
*incl. crushed ice tube and Stainless Steel Faucet***EB 565 E** Edelstahl/Stainless Steel**EB 565 G** Gold/Gold**ELEGANCE Milchkanne**
ELEGANCE Milk Can

Milchbehälter aus Edelstahl, Kühlakku im Standfuß sowie Edelstahl-Crasheisröhre, Edelstahltropfschale und Edelstahlhahn
Milk Container made of Stainless Steel, cooling pack in base, st. st. crushed ice tube, st. st. drip tray and st. st. faucet

5 Liter / 5 Liters**Edelstahl / Stainless Steel****EMC 050 E****Gold (24 Karat hartvergoldet)**
*Gold (24-carat gold plated)***EMC 050 G****Maße / Dimensions:**

☒ 440 ☒ 235 ☒ 370

**Nachschubbehälter (5 Liter)**
inkl. Crasheisröhre und Edelstahlhahn
Spare Container (5 liters)
*incl. crushed ice tube and Stainless Steel Faucet***EB 564 E** Edelstahl/
Stainless Steel**EB 564 G** Gold/Gold**!** Tropfschale, Edelstahlhahn und Milchbehälter sind nicht vergoldet.
Drip Tray, St. St. Faucets and Milk Container are not gold plated.

ELEGANCE Saftkanne 'Extra'
ELEGANCE Juice Dispenser 'Extra'

5 Liter / 5 Liters
mit elektrischem Deckelrührsystem
with electrical lid stirring system

Edelstahl / Stainless Steel

ESC 050 E 005 mit transparentem Zylinder
with transparent container

ESC 050 E 905 mit Zylinder opal
with translucent container

Gold (24 Karat hartvergoldet)
Gold (24-carat gold plated)

ESC 050 G 005 mit transparentem Zylinder
with transparent container

ESC 050 G 905 mit Zylinder opal
with translucent container

Maße / Dimensions:
☰ 475 ☱ 235 ☲ 370



Nachschubbehälter (5 Liter)
inkl. Crasheisröhre und Edelstahlhahn
Spare Container (5 liters)
incl. crushed ice tube and St. St. Faucet

Modell Edelstahl / Model Stainless Steel

EB 502 E (transparent)

EB 502 E 900 (opal/translucent)

Modell Gold / Model Gold

EB 502 G (transparent)

EB 502 G 900 (opal/translucent)

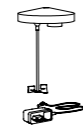

Rührwerk (Nachrüstset)
Stiring Kit (add-on)
EB 547 E Edelstahl / Stainless Steel
EB 547 G Gold



mit transparentem Zylinder
with transparent Container

ELEGANCE Saftkanne 'Aktiv'
ELEGANCE Juice Dispenser 'Aktiv'

5 Liter / 5 Liters
Standfuß mit elektrischer Kühlung
und Deckelrührsystem
*Base with electrical cooling system
and lid stirring system*

Edelstahl / Stainless Steel

ESC 050 E 023 mit transparentem Zylinder
with transparent container

ESC 050 E 923 mit Zylinder opal
with translucent container

Gold (24 Karat hartvergoldet)
Gold (24-carat gold plated)

ESC 050 G 023 mit transparentem Zylinder
with transparent container

ESC 050 G 923 mit Zylinder opal
with translucent container

Maße / Dimensions:
☰ 495 ☱ 235 ☲ 370



Nachschubbehälter (5 Liter)
inkl. Kühlbodenplatte (Aluminium)
und Edelstahlhahn
Spare Container (5 liters)
*incl. cooling bottom plate (aluminium)
and Stainless Steel Faucet*

Modell Edelstahl / Model Stainless Steel

EB 566 E (transparent)

EB 566 E 900 (opal/translucent)

Modell Gold / Model Gold

EB 566 G (transparent)

EB 566 G 900 (opal/translucent)



mit transparentem Zylinder
with transparent Container

ELEGANCE Saftkanne
ELEGANCE Juice Dispenser

9 Liter / 9 Liters
Edelstahl / Stainless Steel
BSC 090 E

Gold (24 Karat hartvergoldet)
Gold (24-carat gold plated)

BSC 090 G

Maße / Dimensions:
☰ 550 ☱ 285 ☲ 362

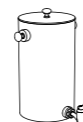

Nachschubbehälter (9 Liter)
inkl. Edelstahlhahn und Griffe
Spare Container (9 liters)
incl. Stainless Steel Faucet and knobs
BB 549 E Edelstahl / Stainless Steel

BB 549 G Gold / Gold



ELEGANCE Milchkanne 'Aktiv'
ELEGANCE Milk Can 'Aktiv'

5 Liter / 5 Liters
Standfuß mit elektrischer Kühlung
und Deckelrührsystem
*Base with electrical cooling system
and lid stirring system*

Edelstahl / Stainless Steel
EMC 050 E 007

Gold (24 Karat hartvergoldet)
Gold (24-carat gold plated)

EMC 050 G 007

Maße / Dimensions:
☰ 495 ☱ 235 ☲ 370



Nachschubbehälter (5 Liter)
mit Edelstahlhahn
Spare Container (5 liters)
with Stainless Steel Faucet
BB 506 E Edelstahl /
Stainless Steel
BB 506 G Gold / Gold



! Tropfschale, Edelstahlhahn und Milchbehälter sind nicht vergoldet.
Drip Tray, St. St. Faucets and Milk Container are not gold plated.



B-LINE Saftkanne
B-LINE Juice Dispenser

Behälter, spülmaschineneignet inkl. Deckel aus Kunststoff. Edelstahlstandfuß mit Kühlakku, Non-Drip-Hahn, Tropfschale aus Kunststoff.
Container, suitable for dishwasher use incl. lid made of plastic. Stainless Steel base with cooling pack, non-drip-faucet, drip tray made of plastic.

2,5 Liter / 2.5 liters

XSC 025 E 004

Maße / Dimensions
 ☒ 425 ☒ 200 ☒ 330

5 Liter / 5 liters

XSC 050 E 004

Maße / Dimensions
 ☒ 485 ☒ 220 ☒ 350

B-LINE Milchkanne
B-LINE Milk Can

Behälter inkl. Deckel aus Edelstahl. Edelstahlstandfuß mit Kühlakku, Non-Drip-Hahn, Tropfschale aus Kunststoff.
Container incl. lid made of stainless steel, Stainless Steel base with cooling pack, non-drip-faucet, drip tray made of plastic.

3 Liter / 3 liters

XMC 030 E 001

Maße / Dimensions
 ☒ 395 ☒ 200 ☒ 350

5 Liter / 5 liters

XMC 050 E 002

Maße / Dimensions
 ☒ 455 ☒ 220 ☒ 350

MÜSLI, KONFI & HONIG / MUESLI, JAM & HONEY

Für den süßen Brotaufstrich und die Cerealien gibt es eine große Auswahl an Spendern und Displays, die für eine moderne oder aber auch rustikale Präsentation sorgen. Dabei bleibt die Funktionalität immer ein wichtiger Baustein bei den FRILICH Artikeln, damit das Buffet nicht nur gut aussieht, sondern auch Pflege und Handling gut von der Hand gehen.

For the sweet spread and cereals, there is a large selection of dispensers and displays that make for a modern and rustic presentation. The functionality is always an important component of FRILICH products, so that the buffet not only looks good, but also easy to care for and handle.

CONNECT Müslibar 'Flöte'
CONNECT Muesli Bar 'Flute'



Müsliflöte 1,5 Liter, zur Präsentation von Cerealien, inkl. Standfuß Modell 'Edelstahl'
Muesli Flute 1.5 liters, for muesli presentation, incl. base model 'Stainless Steel'

ETO 015 E 100

Maße / Dimensions:
☒ 290 ☒ 170 ☒ 154



Nachschubgefäß (1,5 Liter)
inkl. Edelstahldeckel und 'Gute-Nacht-Deckel'
Spare Flute (1.5 liters)
incl. Stainless steel press-on lid and 'Good Night Lid'
EB 549 E Edelstahl / Stainless Steel



Standfuß Modell 'Edelstahl'
Base Model 'Stainless Steel'
EB 634 E

CONNECT Müslibar 'Goblet'
CONNECT Muesli Bar 'Goblet'



Porzellankegel 2 Liter, zur Präsentation von Cerealien, inkl. Standfuß Modell 'Edelstahl'
China Slide 2 liters, for muesli presentation, incl. base model 'Stainless Steel'

ETO 200 E 100

Maße / Dimensions:
☒ 305 ☒ 170 ☒ 220



Porzellankegel (2 Liter)
China Slide (2 liters)
3P0036



Standfuß Modell 'Edelstahl'
Base Model 'Stainless Steel'
EB 634 E

CONNECT Konfitürenbar 'Cup'
CONNECT Jam Bar 'Cup'



Behälter 0,6 Liter zur Präsentation von Konfitüre, mit Edelstahldeckel inkl. Standfuß Modell 'Edelstahl'
Pot 0.6 liters for jam presentation with st. lid incl. base model 'Stainless Steel'

mit Kunststoffbehälter (opal), spülmaschinengeeignet
with Plastic Pot (translucent), dishwasher proof

ECO 006 E 100

mit Porzellanbehälter / with China Pot

ECO 006 E 101

Maße / Dimensions:
☒ 175 ☒ 170 ☒ 154



Nachschubgefäß (0,6 Liter)
mit Edelstahldeckel, spülmaschinengeeignet
Spare pot (0.6 liters)
incl. Stainless steel lid, dishwasher proof



mit Kunststoffbehälter (opal)
inkl. Gute-Nacht-Deckel'
with Plastic Pot (translucent) and Good Night Lid'

EB 585 E

mit Porzellanbehälter / with China Pot
LB 552 E



Standfuß Modell 'Edelstahl'
Base Model 'Stainless Steel'
EB 634 E



CONNECT Müslibar 'Hopper'
CONNECT Muesli Bar 'Hopper'



Müsli-Drehspender aus Edelstahl zur Präsentation von Cerealien, Acrylglasbehälter, Edelstahldeckel und Edelstahldrehachse inkl. Standfuß Modell 'Edelstahl'
Rotary Dispenser st. st. for muesli presentation, acrylic container, st. lid and st. st. rotational axis incl. base model 'Stainless Steel'

2,5 Liter / 2.5 liters:
ETO 250 E 100

Maße / Dimensions:
☒ 725 ☒ 170 ☒ 190

3,5 Liter / 3.5 liters:
ETO 350 E 100

Maße / Dimensions:
☒ 825 ☒ 170 ☒ 190

4,5 Liter / 4.5 liters:
ETO 450 E 100

Maße / Dimensions:
☒ 965 ☒ 170 ☒ 190



'Hopper' Modul
Edelstahlfuß mit Acryl-Kunststoffbehälter, Drehgriff und Deckel aus Edelstahl
'Hopper' Module
St. st. base with acrylic container, st. st. rotational axis and lid

2,5 Liter / 2.5 liters:
EB 599 E 250

3,5 Liter / 3.5 liters:
EB 599 E 350

4,5 Liter / 4.5 liters:
EB 599 E 450



Standfuß Modell 'Edelstahl'
Base Model 'Stainless Steel'
EB 634 E



Optional/optional:
Reinigungsbürste
Cleaning Brush
3ZU026

ELEGANCE Konfitürenbar 'Trio'
ELEGANCE Jam Bar 'Trio'



Kunststoffbehälter (opal)
Inhalt: je 0,6 Liter
Plastic Pot (translucent), Content: 0.6 liters ea.

Edelstahl / Stainless Steel
ECO 018 E

Gold / Gold
ECO 018 G

Maße / Dimensions:
180 470 140



Nachschubgefäß (0,6 Liter)
mit Edelstahldeckel und
'Gute-Nacht-Deckel'
Spare pot (0.6 liters)
incl. Stainless steel lid and
'Good Night Lid'

EB 585 E Edelstahl /
Stainless Steel

EB 585 G Gold / Gold

ELEGANCE Konfitürenbar 'Quadro'
ELEGANCE Jam Bar 'Quadro'



Kunststoffbehälter (opal), Inhalt: je 0,6 Liter
Plastic Pot (translucent), content: 0.6 liters ea.

Edelstahl / Stainless Steel
ECO 024 E 004

Gold / Gold
ECO 024 G 004

Maße / Dimensions:
180 600 140



ELEGANCE Müslibar 'Trio'
ELEGANCE Muesli Bar 'Trio'



Kunststoffbehälter, Inhalt: je 1,5 Liter
Plastic Flute, Content: 1.5 liters ea.

Edelstahl / Stainless Steel
ETO 045 E 002

Gold / Gold
ETO 045 G 002

Maße / Dimensions:
290 470 140



Nachschubgefäß (1,5 Liter)
inkl. Edelstahldeckel und
'Gute-Nacht-Deckel'
Spare Flute (1.5 liters)
incl. Stainless steel press-on lid
and 'Good Night Lid'

EB 549 E Edelstahl /
Stainless Steel

EB 549 G Gold / Gold

ELEGANCE Müslibar 'Quadro'
ELEGANCE Muesli Bar 'Quadro'



Kunststoffbehälter, Inhalt: je 1,5 Liter
Plastic Flute, Content: 1.5 liters ea.

Edelstahl / Stainless Steel
ETO 060 E 002

Gold / Gold
ETO 060 G 002

Maße / Dimensions:
290 600 140



ELEGANCE Honigspender
ELEGANCE Honey Holder



Tropfenfreie Dosierung für 1 kg flüssigen Honig,
Edelstahlgestell, Bedienhebel aus Edelstahl,
Behälter und Dosierventil spülmaschinen-
geeignet, Edelstahldeckel

Dripless dosage for 1 kg liquid honey, st. st. rack,
st. st. operating lever, Container and dispensing
valve are dishwasher-proof, stainless steel lid

EHO 010 E Edelstahl / St. St.

EHO 010 G Gold / Gold

Maße / Dimensions:
Ø 210 350 235



Edelstahldeckel
Stainless Steel Lid
EB 593 E



Edelstahldeckel, vergoldet
Stainless Steel Lid, gold-plated
EB 593 G

RAISER Buffetsystem 'Buffet Bowl Medium 23 x 23' / RAISER Buffet System 'Buffet Bowl Medium 23 x 23'

Porzellankugel (1,5 Liter) inkl. Porzellandeckel auf Standfußrahmen aus Eichenholz, Edelstahl-Dekorplatte
China Bowl with Lid (1,5 liters) on Oak Base Frame, st. st. décor frame

S-Standfuß 'Oak' / S-Base Frame 'Oak' · Maße / Dimension: 274 251 251



weiß / white F08.401.0000 blau / blue F08.401.0001 rot / red F08.401.0002 grau / grey F08.401.0003 caramel / caramel F08.401.0004

L-Standfuß 'Oak' / L-Base Frame 'Oak' · Maße / Dimension: 367 251 251



weiß / white F08.400.0000 blau / blue F08.400.0001 rot / red F08.400.0002 grau / grey F08.400.0003 caramel / caramel F08.400.0004

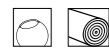

RAISER Buffetsystem 'Buffet Bowl Maxi 23 x 23' / RAISER Buffet System 'Buffet Bowl Maxi 23 x 23'

Porzellankugel (3,5 Liter) inkl. Porzellandeckel auf Standfußrahmen aus Eichenholz, Edelstahl-Dekorplatte
China Bowl with Lid (3,5 liters) on Oak Base Frame, st. st. décor frame

S-Standfuß 'Oak' / S-Base Frame 'Oak' · Maße / Dimension: 336 251 251



weiß / white F07.401.0000 blau / blue F07.401.0001 rot / red F07.401.0002 grau / grey F07.401.0003 caramel / caramel F07.401.0004

L-Standfuß 'Oak' / L-Base Frame 'Oak' · Maße / Dimension: 430 251 251



weiß / white F07.400.0000 blau / blue F07.400.0001 rot / red F07.400.0002 grau / grey F07.400.0003 caramel / caramel F07.400.0004



Porzellankugel (1,5 Liter) inkl. Porzellandeckel auf Standfußrahmen aus Fichtenholz, natur, Edelstahl-Dekorplatte
China Bowl with Lid (1,5 liters) on Spruce Base Frame, st. st. décor frame

M-Standfuß 'Spruce' / M-Base Frame 'Spruce' · Maße / Dimension: 305 228 228



weiß / white F08.201.0000 blau / blue F08.201.0001 rot / red F08.201.0002 grau / grey F08.201.0003 caramel / caramel F08.201.0004

L-Standfuß 'Spruce' / L-Base Frame 'Spruce' · Maße / Dimension: 369 228 228



weiß / white F08.200.0000 blau / blue F08.200.0001 rot / red F08.200.0002 grau / grey F08.200.0003 caramel / caramel F08.200.0004

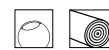

Porzellankugel (3,5 Liter) inkl. Porzellandeckel auf Standfußrahmen aus Fichtenholz, natur, Edelstahl-Dekorplatte
China Bowl with Lid (3,5 liters) on Spruce Base Frame, st. st. décor frame

M-Standfuß 'Spruce' / M-Base Frame 'Spruce' · Maße / Dimension: 365 228 228



weiß / white F07.201.0000 blau / blue F07.201.0001 rot / red F07.201.0002 grau / grey F07.201.0003 caramel / caramel F07.201.0004

L-Standfuß 'Spruce' / L-Base Frame 'Spruce' · Maße / Dimension: 430 228 228



weiß / white F07.200.0000 blau / blue F07.200.0001 rot / red F07.200.0002 grau / grey F07.200.0003 caramel / caramel F07.200.0004



Porzellankugel (1,5 Liter) inkl. Porzellandeckel auf Standfußrahmen aus Fichtenholz, weiß lackiert in 'used look',
Edelstahl-Dekorplatte / China Bowl with Lid (1,5 liters) on Spruce Base Frame, white varnish in 'used look', st. st. décor frame

M-Standfuß 'Vintage White' / M-Base Frame 'Vintage White' · Maße / Dimension: 305 228 228



weiß / white F08.301.0000 blau / blue F08.301.0001 rot / red F08.301.0002 grau / grey F08.301.0003 caramel / caramel F08.301.0004

L-Standfuß 'Vintage White' / L-Base Frame 'Vintage White' · Maße / Dimension: 369 228 228

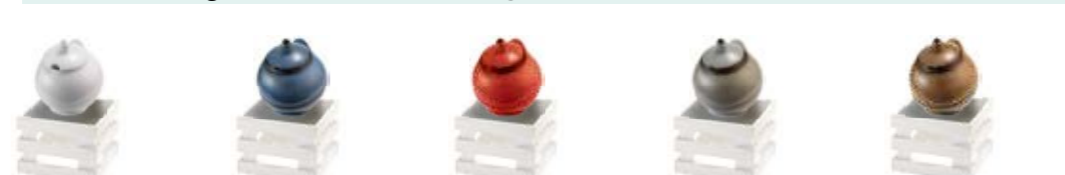

weiß / white F08.300.0000 blau / blue F08.300.0001 rot / red F08.300.0002 grau / grey F08.300.0003 caramel / caramel F08.300.0004



Porzellankugel (3,5 Liter) inkl. Porzellandeckel auf Standfußrahmen aus Fichtenholz, weiß lackiert in 'used look',
Edelstahl-Dekorplatte / China Bowl with Lid (3,5 liters) on Spruce Base Frame, white varnish in 'used look', st. st. décor frame

M-Standfuß 'Vintage White' / M-Base Frame 'Vintage White' · Maße / Dimension: 365 228 228



weiß / white F07.301.0000 blau / blue F07.301.0001 rot / red F07.301.0002 grau / grey F07.301.0003 caramel / caramel F07.301.0004

L-Standfuß 'Vintage White' / L-Base Frame 'Vintage White' · Maße / Dimension: 430 228 228



weiß / white F07.300.0000 blau / blue F07.300.0001 rot / red F07.300.0002 grau / grey F07.300.0003 caramel / caramel F07.300.0004

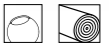

RAISER Buffetsystem 'Buffet Bowl Medium 23 x 23' / RAISER Buffet System 'Buffet Bowl Medium 23 x 23'

Porzellankugel (1,5 Liter) inkl. Porzellandeckel auf Standfußrahmen aus Edelstahl, Edelstahl-Dekorplatte
China Bowl with Lid (1,5 liters) on Stainless Steel Base Frame, st. st. décor frame

S-Standfuß 'Stainless Steel' / S-Base Frame 'Stainless Steel' · Maße / Dimension: 233 H 211 L 211



weiß / white
F08.002.0000



blau / blue
F08.002.0001



rot / red
F08.002.0002



grau / grey
F08.002.0003



caramel / caramel
F08.002.0004

M-Standfuß 'Stainless Steel' / M-Base Frame 'Stainless Steel' · Maße / Dimension: 283 H 211 L 211



weiß / white
F08.001.0000



blau / blue
F08.001.0001



rot / red
F08.001.0002



grau / grey
F08.001.0003



caramel / caramel
F08.001.0004

L-Standfuß 'Stainless Steel' / L-Base Frame 'Stainless Steel' · Maße / Dimension: 333 H 211 L 211



weiß / white
F08.000.0000



blau / blue
F08.000.0001



rot / red
F08.000.0002



grau / grey
F08.000.0003



caramel / caramel
F08.000.0004



RAISER Buffetsystem 'Buffet Bowl Maxi 23 x 23' / RAISER Buffet System 'Buffet Bowl Maxi 23 x 23'

Porzellankugel (3,5 Liter) inkl. Porzellandeckel auf Standfußrahmen aus Edelstahl, Edelstahl-Dekorplatte
China Bowl with Lid (3,5 liters) on Stainless Steel Base Frame, st. st. décor frame

S-Standfuß 'Stainless Steel' / S-Base Frame 'Stainless Steel' · Maße / Dimension: 296 H 220 L 220



weiß / white
F07.002.0000



blau / blue
F07.002.0001



rot / red
F07.002.0002



grau / grey
F07.002.0003



caramel / caramel
F07.002.0004

M-Standfuß 'Stainless Steel' / M-Base Frame 'Stainless Steel' · Maße / Dimension: 346 H 220 L 220



weiß / white
F07.001.0000



blau / blue
F07.001.0001



rot / red
F07.001.0002



grau / grey
F07.001.0003



caramel / caramel
F07.001.0004

L-Standfuß 'Stainless Steel' / L-Base Frame 'Stainless Steel' · Maße / Dimension: 396 H 220 L 220



weiß / white
F07.000.0000



blau / blue
F07.000.0001



rot / red
F07.000.0002



grau / grey
F07.000.0003



caramel / caramel
F07.000.0004



RAISER Buffetsystem 'Buffet Bowl Medium 23 x 23' / RAISER Buffet System 'Buffet Bowl Medium 23 x 23'

Porzellankugel (1,5 Liter) inkl. Porzellandeckel auf Metallstandfußrahmen (schwarz), Black Steel-Dekorplatte
China Bowl with Lid (1,5 liters) on Black Steel Base Frame, Black Steel Décor Frame

S-Standfuß 'Stainless Steel' / S-Base Frame 'Black Steel' · Maße / Dimension: 235 236 236



M-Standfuß 'Black Steel' / M-Base Frame 'Black Steel' · Maße / Dimension: 285 236 236



L-Standfuß 'Black Steel' / L-Base Frame 'Black Steel' · Maße / Dimension: 335 236 236



PURE NATURE Zutaten-Display 'Bowl Bar' / PURE NATURE Condiment Display 'Bowl Bar'

Buche hell / Natural Beech

Bowl Bar S

Inhalt: je 0,5 Liter
besonders für Konfitüre und Nüsse geeignet
Content: 0.5 liters each
particularly suitable for jam and nuts

RCO 015 X 002

Maße / Dimensions:

210 450 125

Bowl Bar M

Inhalt: je 1,5 Liter
besonders für Cerealien und Obst geeignet
Content: 1.5 liters each
particularly suitable for cereals and fruits

RCO 045 X 002

Maße / Dimensions:

285 600 190

Bowl Bar L

Inhalt: je 3,5 Liter
besonders für Cerealien und Obst geeignet
Content: 3.5 liters each
particularly suitable for cereals and fruits

RCO 105 X 002

Maße / Dimensions:

375 750 250



RAISER Buffetsystem 'Buffet Bowl Maxi 23 x 23' / RAISER Buffet System 'Buffet Bowl Maxi 23 x 23'

Porzellankugel (3,5 Liter) inkl. Porzellandeckel auf Metallstandfußrahmen (schwarz), Black Steel-Dekorplatte
China Bowl with Lid (3,5 liters) on Black Steel Base Frame, Black Steel Décor Frame

S-Standfuß 'Black Steel' / S-Base Frame 'Black Steel' · Maße / Dimension: 295 236 236



M-Standfuß 'Black Steel' / M-Base Frame 'Black Steel' · Maße / Dimension: 345 236 236



L-Standfuß 'Black Steel' / L-Base Frame 'Black Steel' · Maße / Dimension: 395 236 236



B-LINE Standfuß in zwei verschiedenen Größen aus Edelstahl.
Kombinationsmöglichkeit mit Konfitürenbehälter und / oder Müsliflöten.
Bitte beachten: die Behälter werden separat bestellt.
*B-LINE Base made of stainless steel in two different sizes.
Possibility to combine with Cups for Jam and / or Muesli flute.
Please note that the containers have to be ordered separately.*



Anwendungsbeispiel A / Example of use A
Maße / Dimensions 280 x 525 x 140



Anwendungsbeispiel B / Example of use B
Maße / Dimensions 280 x 400 x 140



Anwendungsbeispiel C / Example of use C
Maße / Dimensions 150 x 525 x 140

Papierschilder:

Mit dem Standfuß erhalten Sie die Formatvorlage zum Ausdrucken und Ausschneiden der passenden Sortenschilder. Oder fordern Sie die Formatvorlage direkt bei FRILICH an.

*Paper Label: will come along the delivery of the stainless steel base.
Style sheet for printing and cutting out the suitable paper labels.
Or ask your FRILICH contact person for a free data file.*

B-LINE Müsli- und Konfitürenbar
B-LINE Muesli and Jam Bar

Edelstahlstandfuß / Stainless Steel base

für die Präsentation von verschiedenen Sorten. Schlitz zum Einstellen von Sortenschildern.
For a presentation of different sorts incl. slits for displaying labels.



für 3 Sorten / for 3 sorts **XB 560 E**
Maße / Dimensions 45 x 400 x 140



für 4 Sorten / for 4 sorts **XB 561 E**
Maße / Dimensions 45 x 525 x 140

Konfitürenbehälter 0,6 Liter
Jam Pot, 0,6 liters

spülmaschinengeeignet inkl. Kunststoffdeckel mit Löffelaussparung, transparent.
dishwasher-proof incl. plastic lid with spoon-cut-off, transparent.



XB 565
Maße / Dimensions 145 x 105 x 105

Müsliflöte aus Kunststoff, 1,5 Liter
Muesli Flute in plastic, 1,5 liters

spülmaschinengeeignet inkl. Deckel aus Kunststoff, rauchfarben.
dishwasher-proof incl. plastic lid with spoon-cut-off, smoke-colored.



XB 563
Maße / Dimensions 275 x 135 x 105



WURST, KÄSE, SALATE & JOGHURT / COLD CUTS, SALADS & YOGHURT

Bei Wurst, Käse, Joghurt und Salaten ist es besonders wichtig, dass die Temperatur stimmt und die Produkte geschützt, aber doch auch ansprechend präsentiert werden. FRILICH bietet ein breites Sortiment an verschiedenen Buffetlösungen, die unabhängig von fest installierten Kühlmöglichkeiten überall und flexibel eingesetzt werden können. Der Fokus von FRILICH Lösungen liegt dabei immer auf dem Design, ohne dabei die notwendige Funktionalität für den gastronomischen Einsatz aus dem Blick zu verlieren.

With sausages, cheese, yoghurt and salads, it is particularly important, that the temperature on the buffet is right and the products are protected, but at the same time presented in an appealing way. FRILICH offers a wide range of different buffet solutions, that can be used anywhere and flexibly, regardless of fixed cooling options. The focus of FRILICH solutions is always on design, without losing sight of the important functionality for gastronomic use.

PICKNICK Frischeplatte '400'
PICKNICK Freshness Plate '400'



mit Porzellanplatte (Ø 410 mm),
 Standfuß aus spülmaschineneigenem
 Weidekorb (Kunststoff), Standfußbeinsatz aus
 Isoliermaterial, Kühlkissen
*with China Plate (Ø 410 mm), Base made of
 dishwasher proof Wicker Basket (plastic),
 Insulated Cooling Inset, Cooling Cushion*

NFC 000 B 402 (beige)
NFC 000 B 403 (grau/grey))

Maße / Dimensions:
 70 410 410



Anwendungsbeispiel / Example of use

Frischeplatte inkl. Haubensystem
Freshness Plate incl. Hood System
 335 410 435

Haubensystem '400 Platte'
Hood System '400 Plate'



Halterung aus Edelstahl, klappbar, transparente
 Kunststoffhaube (Ø 400 mm) mit Edelstahlgriff
*Stainless Steel Holding device, transparent
 Plastic Hood (Ø 400 mm), with Stainless Steel Handle*
NB 001 E



Porzellanplatte '400'
Spare China Platter '400'
3PO048



Haube / Deckel '400'
 transparente Kunststoffhaube (Ø 400 mm)
 inkl. Edelstahlgriff
Hood / Lid '400'
 transparent Plastic Hood (Ø 400 mm)
 incl. Stainless Steel Knob
EB 641 E

PICKNICK Frischeschale '300'
PICKNICK Freshness Dish '300'



mit Porzellanschale (Ø 310 mm), Standfuß aus
 spülmaschineneigenem Weidekorb (Kunststoff),
 Standfußbeinsatz aus Isoliermaterial, Kühlkissen
*with China Dish (Ø 310 mm), Base made of dishwasher
 proof Wicker Basket (plastic), Insulated Cooling Inset,
 Cooling Cushion*

NFC 030 B 302 (beige)
NFC 030 B 303 (grau/grey))

Maße / Dimensions:
 145 310 310



Anwendungsbeispiel / Example of use

Frischeschale inkl. Haubensystem
Freshness Dish incl. Hood System
 340 310 335

Haubensystem '300 Schale'
Hood System '300 Dish'



Halterung aus Edelstahl, klappbar, transparente
 Kunststoffhaube (Ø 300 mm) mit Edelstahlgriff
*Stainless Steel Holding device, transparent
 Plastic Hood (Ø 300 mm), with Stainless Steel Handle*
NB 004 E



Porzellanschale '300'
Spare China Dish '300'
3PO049



Haube / Deckel '300'
 transparente Kunststoffhaube (Ø 300 mm)
 inkl. Edelstahlgriff
Hood / Lid '300'
 transparent Plastic Hood (Ø 300 mm)
 incl. Stainless Steel Knob
EB 545 E





EARTH Frischeplatte '400'
EARTH Freshness Plate '400'

mit Porzellanplatte (∅ 410 mm),
Standfuß aus Speckstein mit Edelstahlring,
Standfußbeinsatz aus Isoliermaterial, Kühlkissen
with China Plate (∅ 410 mm), Base made of
Soapstone with Stainless Steel Hoop, Insulated
Cooling Inset, Cooling Cushion

NFC 000 E 401

Maße / Dimensions:
∅ 70 H 410 L 410



Anwendungsbeispiel / Example of use

Frischeplatte inkl. Haubensystem
Freshness Plate incl. Hood System

∅ 335 H 410 L 435

Haubensystem '400 Platte'
Hood System '400 Plate'

Halterung aus Edelstahl, klappbar, transparente
Kunststoffhaube (∅ 400 mm) mit Edelstahlgriff
Holding device, transparent Plastic Hood (∅ 400 mm),
with Stainless Steel Handle

NB 001 E



Porzellanplatte '400'
Spare China Platter '400'



3PO048



Haube / Deckel '400'

transparente Kunststoffhaube (∅ 400 mm)
inkl. Edelstahlgriff
Hood / Lid '400'
transparent Plastic Hood (∅ 400 mm)
incl. Stainless Steel Knob

EB 641 E

EARTH Frischeschale '300'
EARTH Freshness Dish '300'

mit Porzellanschale (∅ 310 mm),
Standfuß aus Speckstein mit Edelstahlring,
Standfußbeinsatz aus Isoliermaterial, Kühlkissen
with China Dish (∅ 310 mm), Base made of Soapstone
with Stainless Steel Hoop, Insulated Cooling Inset,
Cooling Cushion

NFC 030 E 301

Maße / Dimensions:
∅ 142 H 310 L 310

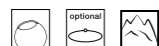

Anwendungsbeispiel / Example of use

Frischeschale inkl. Haubensystem
Freshness Dish incl. Hood System

∅ 340 H 310 L 335

Haubensystem '300 Schale'
Hood System '300 Dish'

Halterung aus Edelstahl, klappbar, transparente
Kunststoffhaube (∅ 300 mm) mit Edelstahlgriff
Stainless Steel Holding device, transparent
Plastic Hood (∅ 300 mm), with Stainless Steel Handle

NB 004 E



Porzellanschale '300'



Spare China Dish

3PO049



Haube / Deckel '300'

transparente Kunststoffhaube (∅ 300 mm)
inkl. Edelstahlgriff
Hood / Lid '300'
transparent Plastic Hood (∅ 300 mm)
incl. Stainless Steel Knob

EB 545 E



RAISER Buffetsystem 'Frischeplatten 33 x 33' / RAISER Buffet System 'Freshness Plates 33 x 33'

Porzellanplatte 33 x 33 mit Kühlkissensystem* auf Standfußrahmen aus Eichenholz
China Plate 33 x 33 with Cooling Cushing System* on Oak Base Frame

S-Standfuß 'Oak' / S-Base Frame 'Oak' · Maße / Dimension: 89 H 351 L 351



weiß / white F01.401.0000 blau / blue F01.401.0001 rot / red F01.401.0002 grau / grey F01.401.0003 caramel / caramel F01.401.0004

L-Standfuß 'Oak' / L-Base Frame 'Oak' · Maße / Dimension: 184 H 351 L 351



weiß / white F01.400.0000 blau / blue F01.400.0001 rot / red F01.400.0002 grau / grey F01.400.0003 caramel / caramel F01.400.0004



Porzellanplatte 33 x 33 mit Kühlkissensystem* auf Standfußrahmen aus Fichtenholz, natur
China Plate 33 x 33 with Cooling Cushing System* on Spruce Base Frame

M-Standfuß 'Spruce' / M-Base Frame 'Spruce' · Maße / Dimension: 119 H 327 L 327



weiß / white F01.201.0000 blau / blue F01.201.0001 rot / red F01.201.0002 grau / grey F01.201.0003 caramel / caramel F01.201.0004

L-Standfuß 'Spruce' / L-Base Frame 'Spruce' · Maße / Dimension: 184 H 327 L 327



weiß / white F01.200.0000 blau / blue F01.200.0001 rot / red F01.200.0002 grau / grey F01.200.0003 caramel / caramel F01.200.0004



Porzellanplatte 33 x 33 mit Kühlkissensystem* auf Standfußrahmen aus Fichtenholz 'Vintage White' in 'used look'
China Plate 33 x 33 with Cooling Cushing System* on Spruce Base Frame 'Vintage White' in 'used look'

M-Standfuß 'Vintage White' / M-Base Frame 'Vintage White' · Maße / Dimension: 119 H 327 L 327



weiß / white F01.301.0000 blau / blue F01.301.0001 rot / red F01.301.0002 grau / grey F01.301.0003 caramel / caramel F01.301.0004

L-Standfuß 'Vintage White' / L-Base Frame 'Vintage White' · Maße / Dimension: 184 H 327 L 327



weiß / white F01.300.0000 blau / blue F01.300.0001 rot / red F01.300.0002 grau / grey F01.300.0003 caramel / caramel F01.300.0004



RAISER Buffetsystem Frischeplatten '33 x 33' / RAISER Buffet System 'Freshness Plates 33 x 33'

Porzellanplatte 33 x 33 mit Kühlkissensystem* auf Standfußrahmen aus Edelstahl
China Plate 33 x 33 with Cooling Cushing System* on Stainless Steel Base Frame

S-Standfuß 'Stainless Steel' / S-Base Frame 'Stainless Steel' · Maße / Dimension: 74 H 324 L 324



weiß / white F01.002.0000 blau / blue F01.002.0001 rot / red F01.002.0002 grau / grey F01.002.0003 caramel / caramel F01.002.0004

M-Standfuß 'Stainless Steel' / M-Base Frame 'Stainless Steel' · Maße / Dimension: 124 H 324 L 324



weiß / white F01.001.0000 blau / blue F01.001.0001 rot / red F01.001.0002 grau / grey F01.001.0003 caramel / caramel F01.001.0004

L-Standfuß 'Stainless Steel' / L-Base Frame 'Stainless Steel' · Maße / Dimension: 174 H 324 L 324



weiß / white F01.000.0000 blau / blue F01.000.0001 rot / red F01.000.0002 grau / grey F01.000.0003 caramel / caramel F01.000.0004



Porzellanplatte 33 x 33 mit Kühlkissensystem* auf Metallstandfußrahmen (schwarz)
China Plate 33 x 33 with Cooling Cushing System* on Black Metal Base Frame

S-Standfuß 'Black Steel' / S-Base Frame 'Black Steel' · Maße / Dimension: 76 H 336 L 336



weiß / white F01.102.0000 blau / blue F01.102.0001 rot / red F01.102.0002 grau / grey F01.102.0003 caramel / caramel F01.102.0004

M-Standfuß 'Black Steel' / M-Base Frame 'Black Steel' · Maße / Dimension: 126 H 336 L 336



weiß / white F01.101.0000 blau / blue F01.101.0001 rot / red F01.101.0002 grau / grey F01.101.0003 caramel / caramel F01.101.0004

L-Standfuß 'Black Steel' / L-Base Frame 'Black Steel' · Maße / Dimension: 176 H 336 L 336



weiß / white F01.100.0000 blau / blue F01.100.0001 rot / red F01.100.0002 grau / grey F01.100.0003 caramel / caramel F01.100.0004



RAISER Buffetsystem 'Frischeschalen 33 x 33' / RAISER Buffet System 'Freshness Dish 33 x 33'

Porzellanschale 33 x 33 mit Kühlkissensystem* auf Standfußrahmen aus Eichenholz
China Bowl 33 x 33 with Cooling Cushing System* on Oak Base Frame

S-Standfuß 'Oak' / S-Base Frame 'Oak' · Maße / Dimension: 120 H 353 L 353



weiß / white F02.401.0000 blau / blue F02.401.0001 rot / red F02.401.0002 grau / grey F02.401.0003 caramel / caramel F02.401.0004

L-Standfuß 'Oak' / L-Base Frame 'Oak' · Maße / Dimension: 215 H 353 L 353



weiß / white F02.400.0000 blau / blue F02.400.0001 rot / red F02.400.0002 grau / grey F02.400.0003 caramel / caramel F02.400.0004



Porzellanschale 33 x 33 mit Kühlkissensystem* auf Standfußrahmen aus Fichtenholz, natur
China Bowl 33 x 33 with Cooling Cushing System* on Spruce Base Frame

M-Standfuß 'Spruce' / M-Base Frame 'Spruce' · Maße / Dimension: 150 H 353 L 353



weiß / white F02.201.0000 blau / blue F02.201.0001 rot / red F02.201.0002 grau / grey F02.201.0003 caramel / caramel F02.201.0004

L-Standfuß 'Spruce' / L-Base Frame 'Spruce' · Maße / Dimension: 215 H 353 L 353



weiß / white F02.200.0000 blau / blue F02.200.0001 rot / red F02.200.0002 grau / grey F02.200.0003 caramel / caramel F02.200.0004



Porzellanschale 33 x 33 mit Kühlkissensystem* auf Standfußrahmen aus Fichtenholz 'Vintage White' in 'used look'
China Bowl 33 x 33 with Cooling Cushing System* on Spruce Base Frame 'Vintage White' in 'used look'

M-Standfuß 'Vintage White' / M-Base Frame 'Vintage White' · Maße / Dimension: 150 H 353 L 353



weiß / white F02.301.0000 blau / blue F02.301.0001 rot / red F02.301.0002 grau / grey F02.301.0003 caramel / caramel F02.301.0004

L-Standfuß 'Vintage White' / L-Base Frame 'Vintage White' · Maße / Dimension: 215 H 353 L 353



weiß / white F02.300.0000 blau / blue F02.300.0001 rot / red F02.300.0002 grau / grey F02.300.0003 caramel / caramel F02.300.0004



RAISER Buffetsystem 'Frischeschalen 33 x 33' / RAISER Buffet System 'Freshness Dish 33 x 33'

Porzellanschale 33 x 33 mit Kühlkissensystem* auf Standfußrahmen aus Edelstahl
China Bowl 33 x 33 with Cooling Cushing System* on Stainless Steel Base Frame

S-Standfuß 'Stainless Steel' / S-Base Frame 'Stainless Steel' · Maße / Dimension: 105 H 353 L 353



weiß / white F02.002.0000 blau / blue F02.002.0001 rot / red F02.002.0002 grau / grey F02.002.0003 caramel / caramel F02.002.0004

M-Standfuß 'Stainless Steel' / M-Base Frame 'Stainless Steel' · Maße / Dimension: 155 H 353 L 353



weiß / white F02.001.0000 blau / blue F02.001.0001 rot / red F02.001.0002 grau / grey F02.001.0003 caramel / caramel F02.001.0004

L-Standfuß 'Stainless Steel' / L-Base Frame 'Stainless Steel' · Maße / Dimension: 205 H 353 L 353



weiß / white F02.000.0000 blau / blue F02.000.0001 rot / red F02.000.0002 grau / grey F02.000.0003 caramel / caramel F02.000.0004



Porzellanschale 33 x 33 mit Kühlkissensystem* auf Metallstandfußrahmen (schwarz)
China Bowl 33 x 33 with Cooling Cushing System* on Black Metal Base Frame

S-Standfuß 'Black Steel' / S-Base Frame 'Black Steel' · Maße / Dimension: 107 H 353 L 353



weiß / white F02.102.0000 blau / blue F02.102.0001 rot / red F02.102.0002 grau / grey F02.102.0003 caramel / caramel F02.102.0004

M-Standfuß 'Black Steel' / M-Base Frame 'Black Steel' · Maße / Dimension: 157 H 353 L 353



weiß / white F02.101.0000 blau / blue F02.101.0001 rot / red F02.101.0002 grau / grey F02.101.0003 caramel / caramel F02.101.0004

L-Standfuß 'Black Steel' / L-Base Frame 'Black Steel' · Maße / Dimension: 207 H 353 L 353



weiß / white F02.100.0000 blau / blue F02.100.0001 rot / red F02.100.0002 grau / grey F02.100.0003 caramel / caramel F02.100.0004



RAISER Buffetsystem 'Frischeplatten 23 x 23' / RAISER Buffet System 'Freshness Plates 23 x 23'

Porzellanplatte 23 x 23 mit Kühlkissensystem* auf Standfußrahmen aus Eichenholz
China Plate 23 x 23 with Cooling Cushing System* on Oak Base Frame

S-Standfuß 'Oak' / S-Base Frame 'Oak' · Maße / Dimension: 89 x 252 x 252



weiß / white F03.401.0000 blau / blue F03.401.0001 rot / red F03.401.0002 grau / grey F03.401.0003 caramel / caramel F03.401.0004

L-Standfuß 'Oak' / L-Base Frame 'Spruce' · Maße / Dimension: 184 x 252 x 252



weiß / white F03.400.0000 blau / blue F03.400.0001 rot / red F03.400.0002 grau / grey F03.400.0003 caramel / caramel F03.400.0004



Porzellanplatte 23 x 23 mit Kühlkissensystem* auf Standfußrahmen aus Fichtenholz, natur
China Plate 23 x 23 with Cooling Cushing System* on Spruce Base Frame

M-Standfuß 'Spruce' / M-Base Frame 'Spruce' · Maße / Dimension: 119 x 230 x 230



weiß / white F03.201.0000 blau / blue F03.201.0001 rot / red F03.201.0002 grau / grey F03.201.0003 caramel / caramel F03.201.0004

L-Standfuß 'Spruce' / L-Base Frame 'Spruce' · Maße / Dimension: 184 x 230 x 230



weiß / white F03.200.0000 blau / blue F03.200.0001 rot / red F03.200.0002 grau / grey F03.200.0003 caramel / caramel F03.200.0004



Porzellanplatte 23 x 23 mit Kühlkissensystem* auf Standfußrahmen aus Fichtenholz 'Vintage White' in 'used look'
China Plate 23 x 23 with Cooling Cushing System* on Spruce Base Frame 'Vintage White' in 'used look'

M-Standfuß 'Vintage White' / M-Base Frame 'Vintage White' · Maße / Dimension: 119 x 230 x 230



weiß / white F03.301.0000 blau / blue F03.301.0001 rot / red F03.301.0002 grau / grey F03.301.0003 caramel / caramel F03.301.0004

L-Standfuß 'Vintage White' / L-Base Frame 'Vintage White' · Maße / Dimension: 184 x 230 x 230



weiß / white F03.300.0000 blau / blue F03.300.0001 rot / red F03.300.0002 grau / grey F03.300.0003 caramel / caramel F03.300.0004



! Einzelteile zu diesen Artikeln Seite 106/107
Spare Parts for these articles page 106/107

*Kunststoffeinsatz mit Kühlkissen unterhalb der Porzellanplatte
Plastic Insert with Cooling Cushion below China Plate

RAISER Buffetsystem 'Frischeplatten 23 x 23' / RAISER Buffet System 'Freshness Plates 23 x 23'

Porzellanplatte 23 x 23 mit Kühlkissensystem* auf Standfußrahmen aus Edelstahl
China Plate 23 x 23 with Cooling Cushing System* on Stainless Steel Base Frame

S-Standfuß 'Stainless Steel' / S-Base Frame 'Stainless Steel' · Maße / Dimension: 74 x 230 x 230



weiß / white F03.002.0000 blau / blue F03.002.0001 rot / red F03.002.0002 grau / grey F03.002.0003 caramel / caramel F03.002.0004

M-Standfuß 'Stainless Steel' / M-Base Frame 'Stainless Steel' · Maße / Dimension: 124 x 230 x 230



weiß / white F03.001.0000 blau / blue F03.001.0001 rot / red F03.001.0002 grau / grey F03.001.0003 caramel / caramel F03.001.0004

L-Standfuß 'Stainless Steel' / L-Base Frame 'Stainless Steel' · Maße / Dimension: 174 x 230 x 230



weiß / white F03.000.0000 blau / blue F03.000.0001 rot / red F03.000.0002 grau / grey F03.000.0003 caramel / caramel F03.000.0004



Porzellanplatte 23 x 23 mit Kühlkissensystem* auf Metallstandfußrahmen (schwarz) / China Plate 23 x 23 with Cooling Cushing System* on Black Metal Base Frame

S-Standfuß 'Black Steel' / S-Base Frame 'Black Steel' · Maße / Dimension: 76 x 230 x 230



weiß / white F03.102.0000 blau / blue F03.102.0001 rot / red F03.102.0002 grau / grey F03.102.0003 caramel / caramel F03.102.0004

M-Standfuß 'Black Steel' / M-Base Frame 'Black Steel' · Maße / Dimension: 126 x 230 x 230



weiß / white F03.101.0000 blau / blue F03.101.0001 rot / red F03.101.0002 grau / grey F03.101.0003 caramel / caramel F03.101.0004

L-Standfuß 'Black Steel' / L-Base Frame 'Black Steel' · Maße / Dimension: 176 x 230 x 230



weiß / white F03.100.0000 blau / blue F03.100.0001 rot / red F03.100.0002 grau / grey F03.100.0003 caramel / caramel F03.100.0004



! Einzelteile zu diesen Artikeln Seite 106/107
Spare Parts for these articles page 106/107

*Kunststoffeinsatz mit Kühlkissen unterhalb der Porzellanplatte
Plastic Insert with Cooling Cushion below China Plate

RAISER Buffetsystem 'Frischeschalen 23 x 23' / RAISER Buffet System 'Freshness Dish 23 x 23'

Porzellanschale 23 x 23 mit Kühlkissensystem* auf Standfußrahmen aus Eichenholz
China Bowl 23 x 23 with Cooling Cushing System* on Oak Base Frame

S-Standfuß 'Oak' / S-Base Frame 'Oak' · Maße / Dimension: 140 254 254



weiß / white
F04.401.0000

blau / blue
F04.401.0001

rot / red
F04.401.0002

grau / grey
F04.401.0003

caramel / caramel
F04.401.0004

L-Standfuß 'Oak' / L-Base Frame 'Oak' · Maße / Dimension: 235 254 254



weiß / white
F04.400.0000

blau / blue
F04.400.0001

rot / red
F04.400.0002

grau / grey
F04.400.0003

caramel / caramel
F04.400.0004



Porzellanschale 23 x 23 mit Kühlkissensystem* auf Standfußrahmen aus Fichtenholz
China Bowl 23 x 23 with Cooling Cushing System* on Spruce Base Frame

M-Standfuß 'Spruce' / M-Base Frame 'Spruce' · Maße / Dimension: 170 254 254



weiß / white
F04.201.0000

blau / blue
F04.201.0001

rot / red
F04.201.0002

grau / grey
F04.201.0003

caramel / caramel
F04.201.0004

L-Standfuß 'Spruce' / L-Base Frame 'Spruce' · Maße / Dimension: 235 254 254



weiß / white
F04.200.0000

blau / blue
F04.200.0001

rot / red
F04.200.0002

grau / grey
F04.200.0003

caramel / caramel
F04.200.0004



Porzellanschale 23 x 23 mit Kühlkissensystem* auf Standfußrahmen aus Fichtenholz 'Vintage White' in 'used look'
China Bowl 23 x 23 with Cooling Cushing System* on Spruce Base Frame 'Vintage White' in 'used look'

M-Standfuß 'Vintage White' / M-Base Frame 'Vintage White' · Maße / Dimension: 170 254 254



weiß / white
F04.301.0000

blau / blue
F04.301.0001

rot / red
F04.301.0002

grau / grey
F04.301.0003

caramel / caramel
F04.301.0004

L-Standfuß 'Vintage White' / L-Base Frame 'Vintage White' · Maße / Dimension: 235 254 254



weiß / white
F04.300.0000

blau / blue
F04.300.0001

rot / red
F04.300.0002

grau / grey
F04.300.0003

caramel / caramel
F04.300.0004



RAISER Buffetsystem 'Frischeschalen 23 x 23' / RAISER Buffet System 'Freshness Dish 23 x 23'

Porzellanschale 23 x 23 mit Kühlkissensystem* auf Standfußrahmen aus Edelstahl
China Bowl 23 x 23 with Cooling Cushing System* on Stainless Steel Base Frame

S-Standfuß 'Stainless Steel' / S-Base Frame 'Stainless Steel' · Maße / Dimension: 125 254 254



weiß / white
F04.002.0000

blau / blue
F04.002.0001

rot / red
F04.002.0002

grau / grey
F04.002.0003

caramel / caramel
F04.002.0004

M-Standfuß 'Stainless Steel' / M-Base Frame 'Stainless Steel' · Maße / Dimension: 175 254 254



weiß / white
F04.001.0000

blau / blue
F04.001.0001

rot / red
F04.001.0002

grau / grey
F04.001.0003

caramel / caramel
F04.001.0004



L-Standfuß 'Stainless Steel' / L-Base Frame 'Stainless Steel' · Maße / Dimension: 225 254 254



weiß / white
F04.000.0000

blau / blue
F04.000.0001

rot / red
F04.000.0002

grau / grey
F04.000.0003

caramel / caramel
F04.000.0004

Porzellanschale 23 x 23 mit Kühlkissensystem* auf Metallstandfußrahmen (schwarz)
China Bowl 23 x 23 with Cooling Cushing* on Black Metal Base Frame

S-Standfuß 'Black Steel' / S-Base Frame 'Black Steel' · Maße / Dimension: 127 254 254



weiß / white
F04.102.0000

blau / blue
F04.102.0001

rot / red
F04.102.0002

grau / grey
F04.102.0003

caramel / caramel
F04.102.0004

M-Standfuß 'Black Steel' / M-Base Frame 'Black Steel' · Maße / Dimension: 177 254 254



weiß / white
F04.101.0000

blau / blue
F04.101.0001

rot / red
F04.101.0002

grau / grey
F04.101.0003

caramel / caramel
F04.101.0004

L-Standfuß 'Black Steel' / L-Base Frame 'Black Steel' · Maße / Dimension: 227 254 254



weiß / white
F04.100.0000

blau / blue
F04.100.0001

rot / red
F04.100.0002

grau / grey
F04.100.0003

caramel / caramel
F04.100.0004



RAISER Buffetsystem 'Buffetschale 23 x 23' / RAISER Buffet System 'Buffet Bowl 23 x 23'

Schräge Porzellanschale 23 x 23 (Ø 280mm) mit Kühlkissensystem* auf Standfußrahmen aus Eichenholz
Slope China Bowl 23 x 23 (Ø 280mm) with Cooling Cushing System* on Oak Base Frame

S-Standfuß 'Oak' / S-Base Frame 'Oak' · Maße / Dimension: 190 H 280 L 280



- | | | | | |
|------------------------------|-----------------------------|---------------------------|-----------------------------|-----------------------------------|
| | | | | |
| weiß / white
F05.401.0000 | blau / blue
F05.401.0001 | rot / red
F05.401.0002 | grau / grey
F05.401.0003 | caramel / caramel
F05.401.0004 |

L-Standfuß 'Oak' / L-Base Frame 'Oak' · Maße / Dimension: 285 H 280 L 280



- | | | | | |
|------------------------------|-----------------------------|---------------------------|-----------------------------|-----------------------------------|
| | | | | |
| weiß / white
F05.400.0000 | blau / blue
F05.400.0001 | rot / red
F05.400.0002 | grau / grey
F05.400.0003 | caramel / caramel
F05.400.0004 |



Schräge Porzellanschale 23 x 23 (Ø 280mm) mit Kühlkissensystem* auf Standfußrahmen aus Fichtenholz, natur
Slope China Bowl 23 x 23 (Ø 280mm) with Cooling Cushing System* on Spruce Base Frame

M-Standfuß 'Spruce' / M-Base Frame 'Spruce' · Maße / Dimension: 220 H 280 L 280



- | | | | | |
|------------------------------|-----------------------------|---------------------------|-----------------------------|-----------------------------------|
| | | | | |
| weiß / white
F05.201.0000 | blau / blue
F05.201.0001 | rot / red
F05.201.0002 | grau / grey
F05.201.0003 | caramel / caramel
F05.201.0004 |

L-Standfuß 'Spruce' / L-Base Frame 'Spruce' · Maße / Dimension: 285 H 280 L 280



- | | | | | |
|------------------------------|-----------------------------|---------------------------|-----------------------------|-----------------------------------|
| | | | | |
| weiß / white
F05.200.0000 | blau / blue
F05.200.0001 | rot / red
F05.200.0002 | grau / grey
F05.200.0003 | caramel / caramel
F05.200.0004 |



Schräge Porzellanschale 23 x 23 (Ø 280mm) mit Kühlkissensystem* auf Standfußrahmen aus Fichtenholz
'Vintage White' in 'used look'
Slope China Bowl 23 x 23 (Ø 280mm) with Cooling Cushing System* on Spruce Base Frame 'Vintage White' in 'used look'

M-Standfuß 'Vintage White' / M-Base Frame 'Vintage White' · Maße / Dimension: 220 H 228 L 228



- | | | | | |
|------------------------------|-----------------------------|---------------------------|-----------------------------|-----------------------------------|
| | | | | |
| weiß / white
F05.301.0000 | blau / blue
F05.301.0001 | rot / red
F05.301.0002 | grau / grey
F05.301.0003 | caramel / caramel
F05.301.0004 |

L-Standfuß 'Vintage White' / L-Base Frame 'Vintage White' · Maße / Dimension: 285 H 228 L 228



- | | | | | |
|------------------------------|-----------------------------|---------------------------|-----------------------------|-----------------------------------|
| | | | | |
| weiß / white
F05.300.0000 | blau / blue
F05.300.0001 | rot / red
F05.300.0002 | grau / grey
F05.300.0003 | caramel / caramel
F05.300.0004 |



! Einzelteile zu diesen Artikeln Seite 106/107
Spare Parts for these articles page 106/107

*Kunststoffeinsatz mit Kühlkissen unterhalb der Porzellanschale
Plastic Insert with Cooling Cushion below China Dish

RAISER Buffetsystem 'Buffetschale 23 x 23' / RAISER Buffet System 'Buffet Bowl 23 x 23'

Schräge Porzellanschale 23 x 23 (Ø 280mm) mit Kühlkissensystem* auf Standfußrahmen aus Edelstahl
Slope China Bowl 23 x 23 (Ø 280mm) with Cooling Cushing System* on Stainless Steel Base Frame

S-Standfuß 'Stainless Steel' / S-Base Frame 'Stainless Steel' · Maße / Dimension: 175 H 280 L 280



- | | | | | |
|------------------------------|-----------------------------|---------------------------|-----------------------------|-----------------------------------|
| | | | | |
| weiß / white
F05.002.0000 | blau / blue
F05.002.0001 | rot / red
F05.002.0002 | grau / grey
F05.002.0003 | caramel / caramel
F05.002.0004 |

M-Standfuß 'Stainless Steel' / M-Base Frame 'Stainless Steel' · Maße / Dimension: 225 H 280 L 280



- | | | | | |
|------------------------------|-----------------------------|---------------------------|-----------------------------|-----------------------------------|
| | | | | |
| weiß / white
F05.001.0000 | blau / blue
F05.001.0001 | rot / red
F05.001.0002 | grau / grey
F05.001.0003 | caramel / caramel
F05.001.0004 |



L-Standfuß 'Stainless Steel' / L-Base Frame 'Stainless Steel' · Maße / Dimension: 275 H 280 L 280



- | | | | | |
|------------------------------|-----------------------------|---------------------------|-----------------------------|-----------------------------------|
| | | | | |
| weiß / white
F05.000.0000 | blau / blue
F05.000.0001 | rot / red
F05.000.0002 | grau / grey
F05.000.0003 | caramel / caramel
F05.000.0004 |

Schräge Porzellanschale 23 x 23 (Ø 280mm) mit Kühlkissensystem* auf Metallstandfußrahmen (schwarz)
Slope China Bowl 23 x 23 (Ø 280mm) with Cooling Cushing System* on Black Metal Base Frame

S-Standfuß 'Black Steel' / S-Base Frame 'Black Steel' · Maße / Dimension: 177 H 280 L 280



- | | | | | |
|------------------------------|-----------------------------|---------------------------|-----------------------------|-----------------------------------|
| | | | | |
| weiß / white
F05.102.0000 | blau / blue
F05.102.0001 | rot / red
F05.102.0002 | grau / grey
F05.102.0003 | caramel / caramel
F05.102.0004 |

M-Standfuß 'Black Steel' / M-Base Frame 'Black Steel' · Maße / Dimension: 227 H 280 L 280



- | | | | | |
|------------------------------|-----------------------------|---------------------------|-----------------------------|-----------------------------------|
| | | | | |
| weiß / white
F05.101.0000 | blau / blue
F05.101.0001 | rot / red
F05.101.0002 | grau / grey
F05.101.0003 | caramel / caramel
F05.101.0004 |

L-Standfuß 'Black Steel' / L-Base Frame 'Black Steel' · Maße / Dimension: 277 H 280 L 280



- | | | | | |
|------------------------------|-----------------------------|---------------------------|-----------------------------|-----------------------------------|
| | | | | |
| weiß / white
F05.100.0000 | blau / blue
F05.100.0001 | rot / red
F05.100.0002 | grau / grey
F05.100.0003 | caramel / caramel
F05.100.0004 |



! Einzelteile zu diesen Artikeln Seite 106/107
Spare Parts for these articles page 106/107

*Kunststoffeinsatz mit Kühlkissen unterhalb der Porzellanschale
Plastic Insert with Cooling Cushion below China Dish

RAISER Buffetsystem 'Rundplatte 23 x 23' / RAISER Buffet System 'Round Plate 23 x 23'

Runde Porzellanplatte 23 x 23 (Ø 230mm) mit Kunststoffhaube spülmaschinengeeignet und Kühlkissensystem* auf Standfußrahmen aus Eichenholz
 Round China Plate 23 x 23 (Ø 230mm) with Plastic Hood suitable for dishwasher use and Cooling Cushioning System* on Oak Base Frame

S-Standfuß 'Oak' / S-Base Frame 'Oak' · Maße / Dimension: 223 H 252 L 252



L-Standfuß 'Oak' / L-Base Frame 'Oak' · Maße / Dimension: 318 H 252 L 252



Runde Porzellanplatte 23 x 23 (Ø 230mm) mit Kunststoffhaube spülmaschinengeeignet und Kühlkissensystem* auf Standfußrahmen aus Fichtenholz, natur
 Round China Plate 23 x 23 (Ø 230mm) with Plastic Hood suitable for dishwasher use and Cooling Cushioning System* on Spruce Base Frame

M-Standfuß 'Spruce' / M-Base Frame 'Spruce' · Maße / Dimension: 253 H 230 L 230



L-Standfuß 'Spruce' / L-Base Frame 'Spruce' · Maße / Dimension: 318 H 230 L 230



Runde Porzellanplatte 23 x 23 (Ø 230mm) mit Kunststoffhaube spülmaschinengeeignet und Kühlkissensystem* auf Standfußrahmen aus Fichtenholz 'Vintage White' in 'used look'
 Round China Plate 23 x 23 (Ø 230mm) with Plastic Hood suitable for dishwasher use and Cooling Cushioning System* on Spruce Base Frame 'Vintage White' in 'used look'

M-Standfuß 'Vintage White' / M-Base Frame 'Vintage White' · Maße / Dimension: 253 H 230 L 230



L-Standfuß 'Vintage White' / L-Base Frame 'Vintage White' · Maße / Dimension: 318 H 230 L 230



RAISER Buffetsystem 'Rundplatte 23 x 23' / RAISER Buffet System 'Round Plate 23 x 23'

Runde Porzellanplatte 23 x 23 (Ø 230mm) mit Kunststoffhaube spülmaschinengeeignet und Kühlkissensystem* auf Standfußrahmen aus Edelstahl
 Round China Plate 23 x 23 (Ø 230mm) with Plastic Hood suitable for dishwasher use and Cooling Cushioning System* on Stainless Steel Base Frame

S-Standfuß 'Stainless Steel' / S-Base Frame 'Stainless Steel' · Maße / Dimension: 208 H 230 L 230



M-Standfuß 'Stainless Steel' / M-Base Frame 'Stainless Steel' · Maße / Dimension: 258 H 230 L 230



L-Standfuß 'Stainless Steel' / L-Base Frame 'Stainless Steel' · Maße / Dimension: 308 H 230 L 230



Runde Porzellanplatte 23 x 23 (Ø 230mm) mit Kunststoffhaube spülmaschinengeeignet und Kühlkissensystem* auf Metallstandfußrahmen (schwarz)
 Round China Plate 23 x 23 (Ø 230mm) with Plastic Hood suitable for dishwasher use and Cooling Cushioning System* on Black Metal Base Frame

S-Standfuß 'Black Steel' / S-Base Frame 'Black Steel' · Maße / Dimension: 210 H 230 L 230



M-Standfuß 'Black Steel' / M-Base Frame 'Black Steel' · Maße / Dimension: 260 H 230 L 230



L-Standfuß 'Black Steel' / L-Base Frame 'Black Steel' · Maße / Dimension: 310 H 230 L 230



Rolltophaube 'GN'
Rolltop Cover 'GN'



Rolltop-Haube mit Griff 1/1 'GN'
Rolltop Hood with knob 1/1 'GN'
10078 Edelstahl / St. St.

Maße / Dimensions:
☞ 240 ☞ 550 ☞ 350



Anwendungsbeispiel
Example of use

Hygieneschutz 'GN'
Hygienic Cover 'GN'



EB 702 E
Maße / Dimensions:
☞ 390 ☞ 650 ☞ 420



Anwendungsbeispiel
Example of use



RAISER Porzellanplatten GN
RAISER China Plates GN



1/1
Maße / Dimensions: ☞ 16 ☞ 530 ☞ 325



1/2
Maße / Dimensions: ☞ 16 ☞ 265 ☞ 325



1/3
Maße / Dimensions: ☞ 16 ☞ 175 ☞ 325



2/4
Maße / Dimensions: ☞ 16 ☞ 530 ☞ 160

Vollplatte 1/1 GN / Full Size Plate 1/1 GN

weiß / white 3PO099
blau / blue 3PO100
rot / red 3PO124
grau / grey 3PO102
caramel / caramel 3PO103

Maße / Dimensions: ☞ 16 ☞ 530 ☞ 325

Teilplatte 1/2 GN / Part Size Plate 1/2 GN

weiß / white 3PO104
blau / blue 3PO105
rot / red 3PO125
grau / grey 3PO107
caramel / caramel 3PO108

Maße / Dimensions: ☞ 16 ☞ 265 ☞ 325

Vollplatte 1/3 GN / Part Size Plate 1/3 GN

weiß / white 3PO109
blau / blue 3PO110
rot / red 3PO126
grau / grey 3PO112
caramel / caramel 3PO113

Maße / Dimensions: ☞ 16 ☞ 175 ☞ 325

Vollplatte 2/4 GN / Part Size Plate 2/4 GN

weiß / white 3PO114
blau / blue 3PO115
rot / red 3PO127
grau / grey 3PO117
caramel / caramel 3PO118

Maße / Dimensions: ☞ 16 ☞ 530 ☞ 160

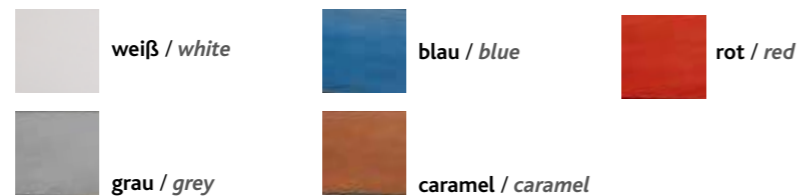

RAISER Buffetsystem 'Frischeplatte GN'
RAISER Buffetsystem 'Freshness Plate GN'

Standfußrahmen aus Holz mit Kunststoffeinsatz und zwei Kühlkissen. Mit Rolltop-Haube bzw. Hygieneschutz ausstattbar (siehe Seite 68). Einsatz verschiedener GN-Porzellanplatten. Bitte separat bestellen!
Wooden Base-Frame with Plastic Insert and two Cooling Cushions. Can be equipped with Rolltop-Hood and Hygienic Cover (see page 68). Use with several GN China Plate options. Please order separately!

Standfuß GN 'Natur', unbehandelt
Wooden Base Frame GN 'Spruce' untreated
RB 649 H

Standfuß GN 'Vintage White'
Wooden Base Frame GN 'Vintage White'
RB 649 H 001

Maße / Dimensions:
☞ 55 ☞ 555 ☞ 350



Anwendungsbeispiel / Example of use

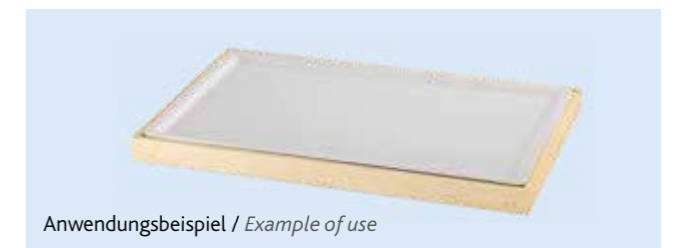

Anwendungsbeispiel / Example of use

UNISON Etagere 'GN'
UNISON Display Stand 'GN'

Mit der praktischen Etagere werden Frisch Frischeplatten im GN-Format platzsparend auf zwei Ebenen platziert.
Auch für den Einsatz der Brotplatte (s. Seite 95) geeignet
With the convenient display stand for food service trays in 1/1 GN size can be placed on two tiers.
Also suitable for the use of Bread Tray (page 95)

AB 513
Edelstahl / Stainless Steel

Maße / Dimensions:
☞ 505 ☞ 635 ☞ 305



Anwendungsbeispiel / Example of use



UNISON Rolltop-Haube 'GN'
UNISON Rolltop Hood 'GN'



mit Griff 1/1 GN
with knob 1/1 GN
10078 Edelstahl / St. St.
10079 Gold / Gold

Maße / Dimensions:
☞ 240 ☞ 550 ☞ 350

! Bei Bedarf Rolltop-Haube oder Hygieneschutz extra bestellen!
Rolltop Hood or Hygienic Cover must be ordered separately!



Anwendungsbeispiel
Example of use

UNISON Hygieneschutz 'GN'
UNISON Hygienic Cover 'GN'



EB 702 E
Maße / Dimensions:
☞ 390 ☞ 650 ☞ 420

! Bei Bedarf Rolltop-Haube oder Hygieneschutz extra bestellen!
Rolltop Hood or Hygienic Cover must be ordered separately!



Anwendungsbeispiel
Example of use

UNISON Frischeplatte 'GN'
UNISON Freshness Plate 'GN'

GN Edelstahl-Standfuß mit Kunststoffeinsatz sowie Kühlkissen. GN Porzellanplatten in verschiedenen Größen.
GN Stainless Steel Base with plastic insert and cooling cushions. GN China Plates in different sizes.

mit Porzellanplatte 1/1 GN / *with china plate 1/1 GN*

EFC 000 E 019 Edelstahl / St. St.
EFC 000 G 019 Gold 24 Karat / Gold 24 Carat

Maße / Dimensions:
☞ 55 ☞ 550 ☞ 345

mit 2 Porzellanplatten 1/2 GN / *with 2 china plates 1/2 GN*

EFC 000 E 020 Edelstahl / St. St.
EFC 000 G 020 Gold 24 Karat / Gold 24 Carat

Maße / Dimensions:
☞ 55 ☞ 550 ☞ 345

mit 3 Porzellanplatten 1/3 GN / *with 3 china plates 1/3 GN*

EFC 000 E 021 Edelstahl / St. St.
EFC 000 G 021 Gold 24 Karat / Gold 24 Carat

Maße / Dimensions:
☞ 55 ☞ 550 ☞ 345



Ersatz-Porzellanplatte 1/1 GN
Spare China Plate 1/1 GN
3PO001

Maße / Dimensions:
☞ 12 ☞ 520 ☞ 325



Ersatz-Porzellanplatte 1/2 GN
Spare China Plate 1/2 GN
3PO003

Maße / Dimensions:
☞ 12 ☞ 265 ☞ 325



Ersatz-Porzellanplatte 1/3 GN
Spare China Plate 1/3 GN
3PO004

Maße / Dimensions:
☞ 12 ☞ 175 ☞ 325



UNISON Etagere 'Rund'
UNISON Display Stand 'Round'

Mit der praktischen Etage werden alle Frischschalen und Frischeplatten im Rundformat platzsparend auf zwei Ebenen platziert. Aus eloxiertem Aluminium mit Fixierungsvorrichtung für die obere Schale/Platte.
With the convenient display stand all round freshness dishes and plates can be placed on two tiers. It is made of anodised aluminium with fixation device for the dish/plate in the upper tier.

EB 630 E
Edelstahl / Stainless Steel

Maße / Dimensions:
☒ 415 ☒ 490 ☒ 410



Anwendungsbeispiel / Example of use



UNISON Hygieneschutz '400' bzw. '300'
UNISON Hygienic Cover '400' resp. '300'

Hygieneschutz für '300'

EB 700 E

Maße / Dimensions: ☒ 390 ☒ 370 ☒ 420

Hygieneschutz für '400'

EB 701 E

Maße / Dimensions: ☒ 390 ☒ 470 ☒ 420



Anwendungsbeispiel
Example of use



UNISON Aufstellhaube '300'
UNISON Set-Up-Hood '300'

Abdeckhaube mit Griff (Ø 300 mm), inkl. Aufstellarm
Cover Hood with knob (Ø 300 mm), incl. Hinged Hood Device

EB 543 E Edelstahl / St. St.
EB 543 G Gold / Gold

Maße / Dimensions:
Ø 300 ☒ 260



Anwendungsbeispiel
Example of use

Beispiel: Wurst- / Käse-Station
Example: Cold Cut Station



UNISON Frischeplatte '300'
UNISON Freshness Plate '300'

Edelstahl-Standfuß mit Kunststoffeinsatz sowie Kühlkissen zum Kühlen der Porzellan-Rundplatte
Stainless Steel Base with plastic insert and cooling cushions with circular china plate

EFC 000 E 018 Edelstahl / St. St.
EFC 000 G 018 Gold 24 Karat / Gold 24 Carat

Maße / Dimensions:
Ø 305 ☒ 45



Ersatz-Porzellanplatte 300
Spare China Plate 300
3PO006

Maße / Dimensions:
☒ 12 ☒ 300 ☒ 300



UNISON Rolltop-Haube '400'
UNISON Rolltop Hood '400'

Rolltop-Haube mit Griff (Ø 400 mm)
Rolltop-Hood with knob (Ø 400 mm)

EB 546 E Edelstahl / St. St.
EB 546 G Gold / Gold

Maße / Dimensions:
Ø 400 ☒ 200



Anwendungsbeispiel
Example of use

UNISON Frischeplatte '400'
UNISON Freshness Plate '400'

Edelstahl-Standfuß mit Kunststoffeinsatz sowie Kühlkissen zum Kühlen der Porzellan-Rundplatte
Stainless Steel Base with plastic insert and cooling cushions with circular china plate

EFC 000 E 405 Edelstahl / St. St.
EFC 000 G 405 Gold 24 Karat / Gold 24 Carat

Maße / Dimensions:
Ø 410 ☒ 50



Ersatz-Porzellanplatte 400
Spare China Plate 400
3PO005

Maße / Dimensions:
☒ 12 ☒ 400 ☒ 400



ELEGANCE Butterschale, 2,5 Liter
ELEGANCE Butter Dish, 2.5 Liters

2,5 Liter / 2.5 Liters

Kunststoffring, Einlegeplatte aus Edelstahl, Kühlakku, Standfuß, Deckel mit Deckelgriff aus Edelstahl

Plastic-Ring, insert plate made of Stainless steel, cooling pack, Base and lid incl. knob made of Stainless Steel

EBC 025 E 001 Edelstahl / *Stainless Steel*

EBC 025 G 001 Gold 24 Karat / *Gold 24 Carat*

Maße / Dimensions:

Ø 185 H 225



Butterschalenring (2,5 Liter)

Plastic Ring for Butter Dish (2.5 liters)

3SA031



Butterschalenring (1,5 Liter)

Plastic Ring for Butter Dish (1.5 liters)

3SA030



ELEGANCE Frischeschale, 2,5 Liter
ELEGANCE Freshness Dish, 2.5 Liters

2,5 Liter / 2.5 Liters

Kunststoffschale, Kühlakku, Standfuß und Deckel mit Deckelgriff aus Edelstahl

Plastic dish, cooling pack, Base and lid incl. knob made of stainless steel

EFC 025 E 001 Edelstahl / *St. St.*

EFC 025 G 001 Gold 24 Karat / *Gold 24 Carat*

Maße / Dimensions:

Ø 185 H 225



Kunststoffschale (2,5 Liter)

Plastic Dish (2.5 liters)

3SA029



1,5 Liter / 1.5 Liters

Kunststoffring, Einlegeplatte aus Edelstahl, Kühlakku, Standfuß, Deckel mit Deckelgriff aus Edelstahl

Plastic-Ring, insert plate made of Stainless steel, cooling pack, Base and lid incl. knob made of Stainless Steel

EBC 015 E 002 Edelstahl / *Stainless Steel*

EBC 015 G 002 Gold 24 Karat / *Gold 24 Carat*

Maße / Dimensions:

Ø 185 H 185



1,5 Liter / 1.5 Liters

Kunststoffschale, Kühlakku, Standfuß und Deckel mit Deckelgriff aus Edelstahl

Plastic dish, cooling pack, Base and lid incl. knob made of stainless steel

EFC 015 E 002 Edelstahl / *St. St.*

EFC 015 G 002 Gold 24 Karat / *Gold 24 Carat*

Maße / Dimensions:

Ø 185 H 185



Kunststoffschale (1,5 Liter)

Plastic Dish (1.5 liters)

3SA028



UNISON Frischeschale '280'
UNISON Freshness Dish '280'

Edelstahl-Standfuß mit Kühlkissen und Porzellanschale

Stainless Steel Base with Cooling Cushion and china bowl

EFC 000 E 014 Edelstahl / *St. St.*

EFC 000 G 014 Gold 24 Karat / *Gold 24 Carat*

Maße / Dimensions:

Ø 285 H 140



Bei Bedarf Haube inkl. Haubenhalter extra bestellen.
Hood incl. Hood holder must be ordered separately.



Porzellanschale (Ø 280 mm)

Spare China Bowl (Ø 280 mm)

3PO008

Optional/optional:



Haube inkl. Haubenhalter

Hood incl. Hood holder

EB 578 E Edelstahl / *St. St.*

EB 578 G Gold / *Gold*



Haube / Hood

EB 571 E Edelstahl / *St. St.*

EB 571 G Gold / *Gold*



UNISON Frischeplatte '230'
UNISON Freshness Plate '230'

Edelstahl-Standfuß mit Kühlkissen und Porzellan-Rundplatte, Abdeckhaube

Stainless Steel Base with Cooling Cushion and circular china platter, cover hood

EFC 000 E 016 Edelstahl / *St. St.*

EFC 000 G 016 Gold 24 Karat / *Gold 24 Carat*

Maße / Dimensions:

Ø 230 H 170

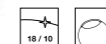

Porzellan-Rundplatte

Spare China Platter

3PO020



Abdeckhaube

Cover Hood

EB 583 E Edelstahl / *St. St.*

EB 583 G Gold / *Gold*



ELEGANCE Frischeschale 'Buffet Bowl'
ELEGANCE Freshness Dish 'Buffet Bowl'

Inhalt: 1,5 Liter
Kunststoffschale/-dekoring (PC, weiß),
transparenter Kunststoffdeckel,
Einsatzschüssel aus Edelstahl, Kühlakku
Content: 1.5 liters
High-grade plastic bowl and decoration ring
(PC, white), transparent plastic lid,
stainless steel insert bowl, cooling pack

EFC 015 K

Maße / Dimensions:
Ø 228 H 158



Nachschubbehälter
Einsatzschüssel aus Edelstahl
Spare Bowl
Stainless steel insert bowl
3BE003



PURE NATURE Frischeschale 'Single'
PURE NATURE Freshness Dish 'Single'

Buche hell / Natural Beech

Frischeschale 'Single S'
Inhalt: 2 Liter
Freshness Dish 'Single S'
Content: 2 liters

RFC 020 X

Maße / Dimensions:
H 270 H 250 L 250

Frischeschale 'Single L'
Inhalt: 2 Liter
Freshness Dish 'Single L'
Content: 2 liters

RFC 020 X 002

Maße / Dimensions:
H 300 H 250 L 250



Porzellanbehälter (2 l)
Spare china dish (2 l)
3BE002



Deckel
China lid
3DE080



SCHÄLCHENHALTER & HYGIENESCHUTZ / BOWL HOLDER & HYGIENIC COVER

Kleine Helfer auf dem Buffet werden immer gebraucht, um das Angebot für den Gast komplett zu machen. Damit die Nachhaltigkeit Einzug beim Gastronom hält, sorgen die Schälchenhalter mit Glasschälchen in unterschiedlichen Größen für das Einsparen von Portionspackungen. Der hygienische Aspekt darf auch nicht unterschätzt werden. Nicht immer ist ein fest installierter Hygieneschutz auf dem Buffet vorhanden. Schnelles Auf- und Abbauen zeichnet die flexiblen Aufsteller von FRILICH aus. Ab sofort gibt es noch 'einen großen Bruder', um auf maximaler Buffetfläche den hygienischen Schutz zu ermöglichen.

Little helpers on the buffet are always needed to complete the offer for the guest. In order to ensure that sustainability is introduced to the catering, the bowl holders with glass bowls in various sizes ensure the saving of portion packaging. The hygienic aspect should not be underestimated either. Not always is a permanently installed hygiene protection on the buffet available. Fast assembly and disassembly characterizes the flexible stands of FRILICH. From now on there is still 'a big brother' to allow maximum buffet area the hygienic protection.

ELEGANCE Schälchenhalter 'Mini'
ELEGANCE Bowl Holder 'Mini'

inkl. 30 Glasschälchen (Ø 60 mm)
incl. 30 glass bowls (Ø 60 mm)

 **Glasschälchen (Ø 60 mm)**
Glass Bowl (Ø 60 mm)
3GL003

EB 616 E Edelstahl / Stainless Steel

EB 616 G 003 Gold 24 Karat / Gold 24 Carat

Maße / Dimensions:
Ø 160 H 210



ELEGANCE Schälchenhalter 'Maxi'
ELEGANCE Bowl Holder 'Maxi'

inkl. 60 Glasschälchen (Ø 70 mm)
incl. 60 glass bowls (Ø 70 mm)

 **Glasschälchen-Set (Ø 70 mm)**
Einheit zu je 6 Glasschälchen
Set of Glass Bowls (Ø 70 mm)
unit of 6 glass bowls
EB 577

EB 616 E 003 Edelstahl / Stainless Steel

Maße / Dimensions:
Ø 205 H 262



 **Schälchenhalter 'Maxi' ohne Glasschälchen**
Bowl Holder 'Maxi' without glass bowls
EB 629 E



Beispiel: Konfitürenstation
Example: Jam Station



Der Hygieneschutz 'Solid' besteht aus zwei äußerst robusten Haltestangen aus Edelstahl, an denen die Plexiglashaube auf fünf verschiedenen Höhen justiert werden kann. Mit einer Fläche von 900 x 500 mm finden somit gleich ganze Buffetsektionen hygienischen Schutz. Die sehr flach konstruierten Füße (H: 4 mm) geben zudem dem Gastronom die Möglichkeit, die gesamte Buffetfläche bis zum letzten Zentimeter effektiv auszunutzen.

The Hygienic Cover 'Solid' consists of two extremely sturdy handrails made of stainless steel, on which the acrylic glass cover can be adjusted to five different heights. With an area of 900 x 500 mm, whole buffet sections are thus hygienically protected. The very flat designed feet (H: 4 mm) give the user the opportunity to use the entire buffet area to the last centimeter effectively.

GUARD Hygieneschutz 'Solid'
GUARD Hygienic Cover 'Solid'

EB 735

Maße / Dimensions:
H 615 H 995 L 560



Ersatzhaube (Acrylglas)
Spare Hood (Acrylic Glass)
EB 733

Maße / Dimensions:
H 30 H 900 L 500



GUARD Hygieneschutz 'Flex 700'
GUARD Hygienic Cover 'Flex 700'



EB 710 E
Höhe / Height: 600
H 745 L 420

EB 703 E
Höhe / Height: 390
H 745 L 420



Anwendungsbeispiel
Example of use

GUARD Hygieneschutz 'Flex GN'
GUARD Hygienic Cover 'Flex GN'



EB 709 E
Höhe / Height: 600
H 650 L 420

EB 702 E
Höhe / Height: 390
H 650 L 420



Anwendungsbeispiel
Example of use

GUARD Hygieneschutz 'Flex 400'
GUARD Hygienic Cover 'Flex 400'



EB 708 E
Höhe / Height: 600
H 470 L 420

EB 701 E
Höhe / Height: 390
H 470 L 420



Anwendungsbeispiel
Example of use

GUARD Hygieneschutz 'Flex 300'
GUARD Hygienic Cover 'Flex 300'



EB 707 E
Höhe / Height: 600
H 370 L 420

EB 700 E
Höhe / Height: 390
H 370 L 420



Anwendungsbeispiel
Example of use



Neigung verstellbar
Inclination adjustable

GUARD Hygieneschutz 'Flex' für Servierplatten- und Schalen bis zu einer Breite von 745 mm. Eine ideale Möglichkeit zum Abdecken von Buffetflächen. FRILICH bietet vier verschiedene Breiten in zwei unterschiedlichen Höhen. Selbstverständlich beinhaltet das Angebot auch eine Lösung für 1/1 GN Größen.

GUARD Hygienic Cover 'Flex' for all serving plates and dishes up to a width of 745 mm. An ideal way to cover buffet areas. FRILICH offers four different widths in two different heights. Of course, the offer also includes hood system for 1/1 GN sizes.

Das Buffet hygienisch einwandfrei und attraktiv gestalten – Frilich hat eine perfekte und zugleich variable Lösung mit vielen Vorzügen entwickelt:

- Hygieneschutz dank unauffälliger Bauteile kaum wahrnehmbar auf dem Buffet
- 4 unterschiedliche Größen in 2 verschiedenen Höhen
- Acrylglas-Hauben sind im Neigungswinkel variabel justierbar
- schnell zusammenzustecken und platzsparend zu verstauen

To present a buffet in hygienically impeccable and attractive manner – Frilich developed a perfect and flexible solution. Profit from convincing advantages:

- Hygienic cover hardly perceivable due to unremarkable modules
- available in 4 different sizes and 2 different heights
- Acrylic glass boards variable adjustable in the pitch
- fast assembly and space saving storing

RAISER Displaysystem 'Cabo™'
RAISER Displaysystem 'Cabo™'

Displaysystem aus Bambus gefertigt
Display System made of Bamboo

Set aus 2 Stück
Set of 2

G06.002.0002

Maße / Dimensions:
☒ 152 ☒ 304 ☒ 304



Displaysystem aus Bambus gefertigt
Display System made of Bamboo

Set aus 3 Stück
Set of 3

G06.002.0000

Maße / Dimensions:
RAISER 1 ☒ 203 ☒ 610 ☒ 304
RAISER 1 ☒ 152 ☒ 457 ☒ 304
RAISER 1 ☒ 102 ☒ 304 ☒ 304



RAISER Displaysystem 'Heights™'
RAISER Displaysystem 'Heights™'

Holzraiser mit zusammenklappbaren Metallbeinen
Wood Raiser with foldable Metal Legs

G06.013.0000

Maße / Dimensions:
☒ 76 ☒ 351 ☒ 191

G06.013.0001

Maße / Dimensions:
☒ 152 ☒ 401 ☒ 211

G06.013.0002

Maße / Dimensions:
☒ 229 ☒ 500 ☒ 249



BROT & UTENSILIEN / BREAD & UTENSILS

Brot auf dem Buffet stellt eine besondere Herausforderung dar, um verschiedene Sorten geschnitten oder am Stück ansprechend aber auch hygienisch zu präsentieren. FRILICH bietet daher hilfreiche Systeme und Displays, die über das Brot hinaus eine Vielzahl von nicht zu kühlenden Produkten hochwertig präsentiert, um ein Stück Erlebnis mit dem Buffet zu vermitteln.

Bread on the buffet is a special challenge in order to offer different varieties sliced or in one piece with a high standard of hygienic and demand. In doing so, FRILICH offers helpful systems and displays that, in addition to bread, presents a variety of non cooling products in a high quality way and convey a piece of experience to buffet setups.



RAISER Brot- und Obststation
RAISER Bread and Fruit Station

Brotstation 'Vintage White'
Bread Station 'Vintage White'

aus Fichtenholz, eingehängte Brotschütte und Teiler zum Bilden von Fächern. mit weißem Lack bearbeitet in 'used look'
made of spruce, hinged Bread chute with divider to create divisions, white varnish in 'used look'

RB 648 H 003

Maße / Dimensions:
☒ 330 ☒ 330 ☒ 740

Obststation 'Vintage White'
Fruit Station 'Vintage White'

aus Fichtenholz, eingehängte Obststeige, mit weißem Lack bearbeitet in 'used look'
made of spruce, hinged fruit crate white varnish in 'used look'

RB 648 H 004

Maße / Dimensions:
☒ 330 ☒ 330 ☒ 750



Brotstation 'Nature'
Bread Station 'Nature'

aus Fichtenholz, eingehängte Brotschütte und Teiler zum Bilden von Fächern
made of spruce, hinged bread chute with divider to create divisions

RB 648 H 001

Maße / Dimensions:
☒ 330 ☒ 330 ☒ 740

Obststation 'Nature'
Fruit Station 'Nature'

aus Fichtenholz, eingehängte Obststeige.
made of spruce, hinged fruit crate

RB 648 H 002

Maße / Dimensions:
☒ 330 ☒ 330 ☒ 750



Anwendungsbeispiele
Examples of use



NEW!



RAISER Brot- und Obststation
RAISER Bread and Fruit Station

Brotstation 'Oak'
Bread Station 'Oak'

aus Eichenholz, eingehängte Brotschütte und Teiler zum Bilden von Fächern
made of oak, hinged bread chute with divider to create divisions

RB 648 H 005

Maße / Dimensions:
☒ 333 ☒ 338 ☒ 756

Obststation 'Oak'
Fruit Station 'Oak'

aus Eichenholz, eingehängte Obststeige.
made of oak, hinged fruit crate

RB 648 H 006

Maße / Dimensions:
☒ 333 ☒ 338 ☒ 764



Anwendungsbeispiele
Examples of use



NEW!

BOX Bread 'Largo'



Stapelbare Brotbox aus Eichenholz, Acryl-Schubfach mit Edelstahlgriff
Stackable bread box made of oak, acrylic drawer with stainless steel knob

BTO 120 H

Maße / Dimensions:
150 x 360 x 377

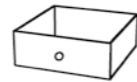

Ersatzschubfach aus Acryl mit Edelstahlgriff
Spare drawer made of acrylic with stainless steel knob

BB 100



Anwendungsbeispiel / Examples of use



Ersatzschubfach aus Acryl mit Edelstahlgriff
Spare drawer made of acrylic with stainless steel knob

BB 101

BOX Bread 'Slender'



Stapelbare Brotbox aus Eichenholz, Acryl-Schubfach mit Edelstahlgriff
Stackable bread box made of oak, acrylic drawer with stainless steel knob

BTO 070 H

Maße / Dimensions:
180 x 180 x 377



NEW!

BOX Bits and Pieces 'Largo'



Stapelbare Box für Gastro-Utensilien aus Eichenholz, Acryl-Schubfach mit Eingriff
Stackable Box for Gastro utensils made of oak, acrylic drawer with opening hole

BTO 014 H

Maße / Dimensions:
79 x 185 x 200



Ersatzschubfach aus Acryl mit Griffmulde
Spare drawer made of acrylic with recessed grip

3PL058



Anwendungsbeispiel / Examples of use



Ersatzschubfach aus Acryl mit mit Griffmulde
Spare drawer made of acrylic with recessed grip

3PL057

BOX Bits and Pieces 'Slender'



Stapelbare Box für Gastro-Utensilien aus Eichenholz, Acryl-Schubfach mit Eingriff
Stackable Box for Gastro utensils made of oak, acrylic drawer with opening hole

BTO 006 H

Maße / Dimensions:
79 x 93 x 200



Ersatzschubfach aus Acryl mit mit Griffmulde
Spare drawer made of acrylic with recessed grip



**NEW!****BOX Brain Food 'Walnut'**

Box mit Abdeckung aus Walnussholz
inkl. 6 Melaminbehälter (je 710ml)
und Sortenschilder (6 Stück),
individuelle Beschriftung bei Bestellung
*Box and cover made of walnut wood with 6 con-
tainer made of melamine (each 710 ml),
individual inscription labels when ordering*

LTO 043 H

Maße / Dimensions:
120 565 250



Melaminbehälter, creme
(je 710ml)
*Melamin Container, Creme
(710ml)*

G08.004.0000**BOX Brain Food 'Oak'**

Box mit Abdeckung aus Eichenholz
inkl. 6 Melaminbehälter (je 710ml)
und Sortenschilder (6 Stück),
individuelle Beschriftung bei Bestellung
*Box and cover made of oak with 6 container
made of melamine (each 710 ml),
individual inscription labels when ordering*

LTO 043 H 001

Maße / Dimensions:
120 565 250



Ersatzschild, Kunststoff mit
Individuellem Schriftzug
*Spare Label, Plastic with
inscription of your choice*

55C003

Accessoires



Lebensmittelechte Papiereinleger
(zweiseitig offen) mit Zeitungsaufdruck
(Französisch), 100 % lebensmittelechte Druckfarbe
*Food Save Tissue Liners (double open bag) with
newsprint (French) 100 % food-safe ink*

G10.006.0002 (2.000 Stück/pieces)

Maße / Dimensions:
139 139



Portionsschälchen
Edelstahl (Inhalt 118 ml)
*St./St. Ramekin
(Capacity 118 ml)*

Ø 7 cm, 48 Stück/pieces

G03.009.0002**ELEGANCE Brotstation**
ELEGANCE Bread Station

Acrylbox (transparent) mit Entnahmeöffnung.
Deckel und Standfuß aus Edelstahl
*Box made of acrylic with drawing window,
lid and base made of stainless steel*

ATO 300 T

Maße / Dimensions:
402 304 405



RAISER Buffetsystem 'Brotkorb 33 x 33' / RAISER Buffetsystem 'Bread Basket 33 x 33'

Korb gefertigt aus Kunststoff, spülmaschinengeeignet mit Auffangschale für Brotkrümel auf Standfußrahmen aus Eichenholz
Basket made of plastic, suitable for dishwasher use with reservoir for bread crumbs on Oak Base Frame



Maße / Dimension: 351 351

Standfuß L
H: 397
beige / beige
F13.400.0000
grau / grey
F13.400.0001

Standfuß S
H: 303
beige / beige
F13.401.0000
grau / grey
F13.401.0001

RAISER Buffetsystem 'Brotkorb 23 x 23' / RAISER Buffetsystem 'Bread Basket 23 x 23'

Korb gefertigt aus Kunststoff, spülmaschinengeeignet mit Auffangschale für Brotkrümel auf Standfußrahmen aus Eichenholz
Basket made of plastic, suitable for dishwasher use with reservoir for bread crumbs on Oak Base Frame



Maße / Dimension: 252 252

Standfuß L
H: 396
beige / beige
F14.400.0000
grau / grey
F14.400.0001

Standfuß S
H: 302
beige / beige
F14.401.0000
grau / grey
F14.401.0001

Korb gefertigt aus Kunststoff, spülmaschinengeeignet mit Auffangschale für Brotkrümel auf Standfußrahmen aus Fichtenholz, natur
Basket made of plastic, suitable for dishwasher use with reservoir for bread crumbs on Spruce Base Frame



Maße / Dimension: 327 327

Standfuß L
H: 398
beige / beige
F13.200.0000
grau / grey
F13.200.0001

Standfuß M
H: 333
beige / beige
F13.201.0000
grau / grey
F13.201.0001

Korb gefertigt aus Kunststoff, spülmaschinengeeignet mit Auffangschale für Brotkrümel auf Standfußrahmen aus Fichtenholz, natur
Basket made of plastic, suitable for dishwasher use with reservoir for bread crumbs on Spruce Base Frame



Maße / Dimension: 228 228

Standfuß L
H: 397
beige / beige
F14.200.0000
grau / grey
F14.200.0001

Standfuß M
H: 332
beige / beige
F14.201.0000
grau / grey
F14.201.0001

Korb gefertigt aus Kunststoff, spülmaschinengeeignet mit Auffangschale für Brotkrümel auf Standfußrahmen aus Fichtenholz, weiß lackiert in 'used look'
Basket made of plastic, suitable for dishwasher use with reservoir for bread crumbs on Spruce Base Frame, white varnish in 'used look'



Maße / Dimension: 327 327

Standfuß L
H: 398
beige / beige
F13.300.0000
grau / grey
F13.300.0001

Standfuß M
H: 333
beige / beige
F13.301.0000
grau / grey
F13.301.0001

Korb gefertigt aus Kunststoff, spülmaschinengeeignet mit Auffangschale für Brotkrümel auf Standfußrahmen aus Fichtenholz, weiß lackiert in 'used look'
Basket made of plastic, suitable for dishwasher use with reservoir for bread crumbs on spruce base frame, white varnish in 'used look'



Maße / Dimension: 228 228

Standfuß L
H: 397
beige / beige
F14.300.0000
grau / grey
F14.300.0001

Standfuß M
H: 332
beige / beige
F14.301.0000
grau / grey
F14.301.0001

Korb gefertigt aus Kunststoff, spülmaschinengeeignet mit Auffangschale für Brotkrümel auf Edelstahlstandfuß-Rahmen
Basket made of plastic, suitable for dishwasher use with reservoir for bread crumbs on Stainless Steel Base Frame



Maße / Dimension: 311 311

Standfuß L
H: 387
beige / beige
F13.000.0000
grau / grey
F13.000.0001

Standfuß M
H: 337
beige / beige
F13.001.0000
grau / grey
F13.001.0001

Standfuß S
H: 287
beige / beige
F13.002.0000
grau / grey
F13.002.0001

Korb gefertigt aus Kunststoff, spülmaschinengeeignet mit Auffangschale für Brotkrümel auf Edelstahlstandfuß-Rahmen
Basket made of plastic, suitable for dishwasher use with reservoir for bread crumbs on Stainless Steel Base Frame



Maße / Dimension: 211 211

Standfuß L
H: 362
beige / beige
F14.000.0000
grau / grey
F14.000.0001

Standfuß M
H: 312
beige / beige
F14.001.0000
grau / grey
F14.001.0001

Standfuß S
H: 262
beige / beige
F14.002.0000
grau / grey
F14.002.0001

Korb gefertigt aus Kunststoff, spülmaschinengeeignet mit Auffangschale für Brotkrümel auf schwarzem Metallstandfuß-Rahmen
Basket made of plastic, suitable for dishwasher use with reservoir for bread crumbs on Black Steel Base Frame



Maße / Dimension: 336 336

Standfuß L
H: 389
beige / beige
F13.100.0000
grau / grey
F13.100.0001

Standfuß M
H: 339
beige / beige
F13.101.0000
grau / grey
F13.101.0001

Standfuß S
H: 289
beige / beige
F13.102.0000
grau / grey
F13.102.0001

Korb gefertigt aus Kunststoff, spülmaschinengeeignet mit Auffangschale für Brotkrümel auf schwarzem Metallstandfuß-Rahmen
Basket made of plastic, suitable for dishwasher use with reservoir for bread crumbs on Black Steel Base Frame



Maße / Dimension: 236 236

Standfuß L
H: 364
beige / beige
F14.100.0000
grau / grey
F14.100.0001

Standfuß M
H: 314
beige / beige
F14.101.0000
grau / grey
F14.101.0001

Standfuß S
H: 264
beige / beige
F14.102.0000
grau / grey
F14.102.0001

RAISER Buffetsystem 'Obstkorb 33 x 33' / RAISER Buffetsystem 'Fruit Basket 33 x 33'

Metallkorb verchromt auf Standfuß-Rahmen aus Eichenholz
 Metal Basket chromium plated on Oak Base Frame

Maße / Dimension: 351 x 351



Standfuß L
 H: 307
 F11.400.0000



Standfuß S
 H: 213
 F11.401.0000



RAISER Buffetsystem 'Zutaten-Display 33 x 33' / RAISER Buffetsystem 'Condiment Basket 33 x 33'

Metallkorb verchromt, Standfuß-Rahmen aus Eichenholz
 Metal Basket chromium plated on Oak Base Frame

Maße / Dimension: 351 x 351



Standfuß L
 H: 307
 F12.400.0000



Metallkorb verchromt, Standfuß-Rahmen aus Fichtenholz, natur
 Metal Basket chromium plated on Spruce Base Frame

Maße / Dimension: 348 x 348



Standfuß L
 H: 308
 F11.200.0000



Standfuß M
 H: 243
 F11.201.0000



Metallkorb verchromt, Standfuß-Rahmen aus Fichtenholz, natur
 Metal Basket chromium plated on Spruce Base Frame

Maße / Dimension: 327 x 327



Standfuß L
 H: 175
 F12.200.0000



Standfuß M
 H: 110
 F12.201.0000



Metallkorb verchromt, Standfuß-Rahmen aus Fichtenholz, weiß lackiert in 'used look'
 Metal Basket chromium plated on Spruce Base Frame, white varnish in 'used look'

Maße / Dimension: 348 x 348



Standfuß L
 H: 308
 F11.300.0000



Standfuß M
 H: 243
 F11.301.0000



Metallkorb verchromt, Standfuß-Rahmen aus Fichtenholz, weiß lackiert in 'used look'
 Metal Basket chromium plated on Spruce Base Frame, white varnish in 'used look'

Maße / Dimension: 327 x 327



Standfuß L
 H: 175
 F12.300.0000



Standfuß M
 H: 110
 F12.301.0000



Metallkorb verchromt auf schwarzem Metallstandfuß-Rahmen
 Metal Basket chromium plated on Black Steel Base Frame

Maße / Dimension: 348 x 348



Standfuß L · H: 300
 F11.100.0000



Standfuß M · H: 250
 F11.101.0000



Standfuß S · H: 200
 F11.102.0000



Metallkorb verchromt auf schwarzem Metallstandfuß-Rahmen
 Metal Basket chromium plated on Black Steel Base Frame

Maße / Dimension: 336 x 336



Standfuß L · H: 167
 F12.100.0000



Standfuß M · H: 117
 F12.101.0000



Metallkorb verchromt auf Edelstahlstandfuß-Rahmen
 Metal Basket chromium plated on Stainless Steel Base Frame

Maße / Dimension: 348 x 348



Standfuß L · H: 300
 F11.000.0000



Standfuß M · H: 250
 F11.001.0000



Standfuß S · H: 200
 F11.002.0000



Anwendungsbeispiele
 Examples of use



PURE NATURE Butcher Block, 'S-Cube'
PURE NATURE Cheese Stand, 'S-Cube'



Buche hell
Natural Beech

Höhe: 120
Height: 120

3ST084

Höhe: 165
Height: 165

3ST083

Höhe: 210
Height: 210

3ST082

Maße / Dimensions:

■ 220 ■ 220



PURE NATURE Butcher Block, 'Oblong'
PURE NATURE Cheese Stand, 'Oblong'



Buche hell
Natural Beech

Höhe: 120
Height: 120

3ST125

Höhe: 165
Height: 165

3ST126

Höhe: 210
Height: 210

3ST127

Maße / Dimensions:

■ 325 ■ 220



PURE NATURE Butcher Block, 'L-Cube'
PURE NATURE Cheese Stand, 'L-Cube'



Buche hell
Natural Beech

Höhe: 120
Height: 120

3ST162

Höhe: 165
Height: 165

3ST161

Höhe: 210
Height: 210

3ST160

Maße / Dimensions:

■ 325 ■ 325



Beispiel: Brotstation
Example: Bread Station



ELEGANCE Brotplatte
ELEGANCE Bread Tray

Holzblech mit Auffangbehälter
 für Brotkrümel aus Edelstahl
*Bread board (wood) with
 stainless steel reservoir for bread crumbs*

Maße / Dimensions:

■ 35 ■ 580 ■ 375



Optional/optional:
Rolltop-Haube eckig (1/1 GN)
Rolltop Hood rectangular (1/1 GN)
10078



Hygieneschutz für Brotplatte
*Hygienic Cover for
 bread cutting board*
EB 702 E

! Bei Bedarf Rolltop-Haube oder Hygieneschutz
 extra bestellen!
*Rolltop Hood or Hygienic Cover must be
 ordered separately!*

Anwendungsbeispiele
Examples of use



STRUCTURE Etagere 'Maxi'
STRUCTURE Display Stand 'Maxi'**Buffetpräsentation**
Buffet Presentation

Dreistufige Etagere, verchromt für Porzellanplatten '33 x 33' (Artikel: 3PO027)
Display Stand on three tiers, chromium plated, for China Plates '33 x 33' (Article: 3PO027)

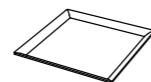
3ST080**Maße / Dimensions:**
☒ 760 ☒ 520 ☒ 360

Porzellanplatte, weiß
China Plate, white
3PO027

! Porzellanplatten extra bestellen
China Plates must be ordered separately

! Passend auch für Porzellanplatten '33 x 33' (Seite 106)
Also with China Plates '33 x 33' (see page 106)

**STRUCTURE Etagere 'Mini'**
STRUCTURE Display Stand 'Mini'**Buffet- und Tischpräsentation**
Buffet and Table Presentation

Zweistufige Etagere, verchromt für Porzellanplatten, Teilplatte klein (Artikel: 3PO029)
Display Stand on two tiers, chromium plated, for China Plates, Partial Plate, small (Article: 3PO029)

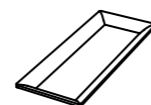
3ST109**Maße / Dimensions:**
☒ 305 ☒ 190 ☒ 325

Porzellanplatte, weiß
China Plate, white
3PO029

Dreistufige Etagere, verchromt für Porzellanplatten, Teilplatte klein (Artikel: 3PO029)
Display Stand on three tiers, chromium plated, for China Plates, Partial Plate, small (Article: 3PO029)

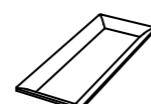
3ST110**Maße / Dimensions:**
☒ 455 ☒ 190 ☒ 325

Porzellanplatte, weiß
China Plate, white
3PO029

! Porzellanplatten extra bestellen
China Plates must be ordered separately

**GASTRO**

Auch in der Systemverpflegung besteht Anspruch auf funktionelle Helfer, die einerseits den Service bei der Präsentation verschiedener Gastronomieartikel unterstützen, andererseits aber auch robust im Umgang und formschön im Design sein sollen. Auf den nächsten Seiten bietet FRILICH einige Lösungen, die nicht nur bei der Kaffeeausgabe, sondern auch bei vielen Anforderungen den Gastronom in seinem Arbeitsumfeld entlasten.

Also in the system catering, there is a demand for functional helpers, who on the one hand supports the service in the presentation of various gastronomic articles, but on the other hand, should also be robust in their handling shapely in design. On the following pages, FRILICH offers a number of solutions that relieve the caterer of his working environment, not just when it comes to dispensing coffee, but also for many other requirements.

Anwendungsbeispiele
Examples of use



inkl. Wandmontage
incl. wall fastening

Vario Rack 'Metropol'



Aluminium-Trägerplatte
mit 3 Aufnahmelöchern
Aluminium Mounting Plate
with 3 location holes
DB 053

Maße
(Standfuß mit Trägerplatte)
Dimensions
(Base with Mounting Plate)
☞ 427 ☞ 150 ☞ 210

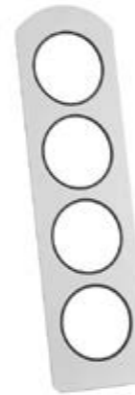

Aluminium-Trägerplatte
mit 4 Aufnahmelöchern
Aluminium Mounting Plate
with 4 location holes
DB 054

Maße
(Standfuß mit Trägerplatte)
Dimensions
(Base with Mounting Plate)
☞ 549 ☞ 150 ☞ 210

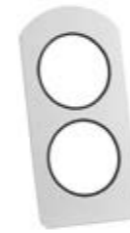

Aluminium-Trägerplatte
mit 2 Aufnahmelöchern
Aluminium Mounting Plate
with 2 location holes
DB 052

Maße
(Standfuß mit Trägerplatte)
Dimensions
(Base with Mounting Plate)
☞ 294 ☞ 160 ☞ 210



Wandmontage inkl. Schraubensatz
(Metall, pulverbeschichtet)
schwarz, zum Befestigen der Trägerplatten
Wall fastening incl. screw set
(metal, powder coated)
black, for fastening of mounting plates
DB 055

Maße / Dimensions: ☞ 80 ☞ 145 ☞ 200



Kunststoff-Standfuß
schwarz, zum Einsetzen der Trägerplatten
Plastic Base
black, for insertion of mounting plates
DB 051



1 Becher 0,6 Liter, opal
Cup 0.6 liters, opal
3SA053



2 Becherteiler
(für kleine Sachets), opal
Cup Divider, opal
(for smallest sachets)
1ME016



3 Becherverlängerung
(für Besteckpräsentation), opal
Cup Extension, opal
(for presentation of cutlery)
1ME018



4 Schütte 0,6 Liter, opal
Product Dish 0.6 liters, opal
1ME015



5 Schütte 1 Liter, opal
Product Dish 1 liter, opal
1ME022



6 Schütte 2 Liter, opal
Product Dish 2 liter, opal
1ME023



Frischeschälchen (Edelstahl)
Inkl. Kühlakku
Small Cooling Dish
(Stainless Steel)
incl. Cooling Pack
DB 045

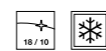

Anwendungsbeispiele
Examples of use





Streuzyucker-Spender 'Trio' Granulated Sugar Dispenser 'Trio'

Inhalt: 2 Liter Kaffeesahne
1 kg Streuzucker
Content: 2 liters coffee cream
1 kg granulated sugar

DFO 002 A 017

Maße / Dimensions:
E 445 H 335 L 340



- siehe Streuzucker- und Kaffeesahnespender 'Uno'
- inkl. Beschriftung 'Zucker' / 'Milch'
 - mit praktischem Schälchen für Süßstoffspender
 - einfache Bedienung und Reinigung
 - Dosierventil stets trocken reinigen
- see Granulated Sugar Dispenser and Coffee Cream Dispenser 'Uno'
- comes with product lettering 'Zucker' / 'Milch' or with stickers 'Sugar' / 'Milk' in languages on request
 - with handy holder for sweetener
 - simple operation and cleaning
 - always keep dispenser valve dry

 Nachschubbehälter für 2 Liter Kaffeesahne
Spare Container for coffee cream 2 liters
DB 025



Streuzyucker-Spender 'Uno' Granulated Sugar Dispenser 'Uno'

Inhalt: 1 kg
Content: 1 kg

DTO 002 N 003

Maße / Dimensions:
E 445 H 208 L 340



- inkl. Beschriftung 'Zucker'
- einmal Dosieren entspricht einem Teelöffel
- einfache Bedienung und Reinigung
- Dosierventil stets trocken reinigen
- press once to get one teaspoon of sugar
- simple operating and cleaning
- comes with product lettering 'Zucker' or with sticker 'Sugar' in languages on request
- always keep dispenser valve dry



Kaffeesahne-Spender 'Uno' Coffee Cream Dispenser 'Uno'

Inhalt: 2 Liter
Content: 2 liters

DFO 002 A 016

Maße / Dimensions:
E 360 H 208 L 340



- inkl. Beschriftung 'Milch', Kühlakku im Standfuß sowie Austausch-Akku
- hygienisch dosiert mit Edelstahlhahn
- Innenbehälter für Kaffeesahne aus Edelstahl
- comes with product lettering 'Milch' or with sticker 'Milk' in languages on request
- cooling pack in base as well as replacement pack
- hygienic dispensing with the Frilich high-grade stainless steel faucet
- inner cream container in high-grade stainless steel

 Nachschubbehälter für 2 Liter Kaffeesahne
Spare Container for coffee cream 2 liters
DB 025



Vario Rack 'Farm'

mit drei schmalen Körben
with three slim baskets

Displaykörbe (à 0,7 Liter) aus Kunststoff gefertigt, beige, spülmaschinengeeignet, Edelstahlrahmen mit Standfüßeinlage aus Holz
Display Baskets (à 0,7 Liter) made of Plastic, beige. Suitable for dishwasher use, Stainless Steel Frame with Wooden Base Insert

DVO 020 H

Maße / Dimensions:
E 370 H 180 L 310



Displaykorb aus Kunststoff gefertigt, beige
Display Basket made of Plastic, beige

schmal / slim
3K0023
E 50 H 145 L 210



Standfüßeinlage aus Holz
Wooden Base Insert

für Vario Rack 'Farm' mit schmalen Körben
for Vario Rack 'Farm' with slim baskets

DB 056



mit drei breiten Körben
with three wide baskets

Displaykörbe (à 1,7 Liter) aus Kunststoff gefertigt, spülmaschinengeeignet, Edelstahlrahmen mit Standfüßeinlage aus Holz
Display Baskets (à 1,7 Liter) made of Plastic, suitable for dishwasher use, Stainless Steel Frame with Wooden Base Insert

DVO 050 H

Maße / Dimensions:
E 370 H 335 L 310



Displaykorb aus Kunststoff gefertigt, beige
Display Basket made of Plastic, beige

breit / wide
3K0022
E 50 H 320 L 210



Standfüßeinlage aus Holz
Wooden Base Insert

für Vario Rack 'Farm' mit breiten Körben
for Vario Rack 'Farm' with wide baskets

DB 057



Reinigungsbürsten
Cleaning Brushes



Reinigungsbürste für Acrylglasröhre
CONNECT Juicer und CONNECT Hopper
Cleaning Brush for CONNECT Juicer and CONNECT Hopper
3ZU026



Reinigungsbürste für Karaffen, Glas bzw. Kunststoff
CARAFINE und CONNECT
Cleaning Brush for CARAFINE and CONNECT Carafes (Glass and Plastic)
3ZU063

Schilder
Label



Tafelschild selbstklebend
25 Stück inkl. Kreide-Schreibset, weiß (6 Stück)
Blackboard Sticker, stick-on
25 pcs. incl. crayon set (6 pcs.)
EB 714 K



Kettenschild aus Holz
mit individueller Beschriftung
Label Chain (wood)
individual inscription
5SC001



Steckschild aus Holz
mit individueller Beschriftung
Insert Label (wood)
Inscription of choice
5SC002



Anwendungsbeispiele
Examples of use

Schilderhalter
Label Holders



Halter, Naturstein
zum Einstellen von Tischkarten und Platzkarten
Holder, Natural Stone
to clip name or place cards

Carrara / Carrara
3SH010

Granit / Granite
3SH011

Basalt / Basalt
3SH012



Halter
zum Einstellen von Tischkarten und Platzkarten
Holder
to clip name or place cards
Holz, Dekor Kirsche / Wood, Décor cherry
3SH013



Schilderfeder Edelstahl
zum Einklemmen von Tischkarten und Platzkarten
Label Clip Stainless Steel
to clip name or place cards
8SH001

Aufstellschilder
Free-Standing Labels



Modell Edelstahl
mit individueller Beschriftung (gelasert), bis zu drei verschiedene Sprachen auf einem Schild möglich
Model Stainless Steel
laser-engraved, inscription of choice, up to three languages per label possible
3SC330E Edelstahl / Stainless Steel
3SC330G Gold / Gold

Lackstift
Lacquer Pen



Lackstift
zur Ausbesserung von Lackschäden der RAISER ('Black Steel')
Lacquer Pen
for repair of lacquer on damaged black iron base RAISER (Black Steel)
3ZU024

Laserbeschriftung
Laser Marking



Laserservice für alle FRILICH Edelstahl-Deckel (individuelle Beschriftung, bis zu drei verschiedene Sprachen auf einem Edelstahl-Deckel möglich)
Laser-engraving for all FRILICH st. st. lids (inscription of choice, up to three languages per lid possible)

9DE001



Laserservice für alle FRILICH Edelstahl-Deckel (Motive in verschiedenen Fruchtarten)
Laser-engraving for all FRILICH st. st. lids (Motifs in different sorts of fruits)

 Motiv ,Orange' Motif 'Orange' 9DE002	 Motiv ,Erdbeere' Motif 'Strawberry' 9DE005	 Motiv ,Pfirsich' Motif 'Peach' 9DE004	 Motiv ,Grapefruit' Motif 'Grapefruit' 9DE014	 Motiv ,Wasser' Motif 'Water' 9DE016
 Motiv ,Kiwi' Motif 'Kiwi' 9DE006	 Motiv ,Wassermelone' Motif 'Water Melon' 9DE007	 Motiv ,Birne' Motif 'Pear' 9DE008	 Motiv ,Kirsche' Motif 'Cherry' 9DE010	 Motiv ,Apfel' Motif 'Apple' 9DE003
 Motiv ,Traube' Motif 'Grape' 9DE011	 Motiv ,Multivitamin' Motif 'Fruits' 9DE017	 Motiv ,Pflaume' Motif 'Plum' 9DE013	 Motiv ,Milch' Motif 'Milk' 9DE015	 Motiv ,Banane' Motif 'Banana' 9DE018

! Weitere Laserbeschriftungen auf Anfrage erhältlich
Ask for more variations of laser markings

Laserservice
Laser-Engraving



Anwendungsbeispiel
Example of use

Für FRILICH Produkte aus Edelstahl oder Holz sind individuell gelaserte Beschriftungen möglich. Saftkannen, Müsliflöten und vieles mehr erhalten so ihre persönliche gelaserte oder bedruckte Kennzeichnung. Wenden Sie sich an Ihren FRILICH Ansprechpartner. FRILICH products in Stainless Steel or Wood can be individually scripted. This way, juice dispensers, muesli flutes and many more products obtain their personal mark (as engraving or print). Please contact FRILICH for further information.



Anwendungsbeispiele
Examples of use

Spoon Rest



Porzellanschälchen für Vorlegebesteck
China Bowl, small, for serving cutlery

3PO054

Maße / Dimensions:
18 x 60 x 80



Anwendungsbeispiel
Example of use

Löffel (Kunststoff)
Spoons (Plastic)



Löffel für Konfitürenbar
Spoon for Jam Bar
3ZU001



Löffel für Frischeschale
Spoon for Freshness Dish
3ZU007

Besteck (Edelstahl)
Cutlery (Stainless Steel)



Vorlegegabel (29 cm)
für FRILICH Schalen
Serving Fork
for FRILICH Dish/Bowl
3ZU037



Vorlegelöffel (29 cm)
für FRILICH Schalen
Serving Spoon
for FRILICH Dish/Bowl
3ZU038



Schöpfkelle für FRILICH Bowl Bar S
Ladle for FRILICH Bowl S
3ZU039



Schöpfkelle für FRILICH Bowl Bar M
Ladle for FRILICH Bowl M
3ZU040



Schöpfkelle (26 cm)
für FRILICH Bowl Bar L
Ladle for FRILICH Bowl L
3ZU041



Aufschnittgabel (18 cm)
für FRILICH Plattensysteme
Fork for cold cuts
for FRILICH platter systems
3ZU042







































































Servierzange, klein
für FRILICH Plattensysteme
Serving Gripper, small
for FRILICH platter systems
3ZU043





Konfitürenlöffel, lang
Long necked Spoon for Jam
3ZU044

RAISER















 Standfußrahmen 'Oak' Base Frame 'Oak' 33x33 Höhe/Height: L 5ST084	 Standfußrahmen 'Spruce' Base Frame 'Spruce' 33x33 Höhe/Height: L 5ST050	 Standfußrahmen 'Vintage White' Base Frame 'Vintage White' 33x33 Höhe/Height: L 5ST049	 Standfußrahmen 'Edelstahl' Base Frame 'Stainless Steel' 33x33 Höhe/Height: L 3ST100	 Standfußrahmen 'Black Steel' Base Frame 'Black Steel' 33x33 Höhe/Height: L 3ST085
 Standfußrahmen 'Oak' Base Frame 'Oak' 33x33 Höhe/Height: S 5ST085	 Standfußrahmen 'Spruce' Base Frame 'Spruce' 33x33 Höhe/Height: M 5ST052	 Standfußrahmen 'Vintage White' Base Frame 'Vintage White' 33x33 Höhe/Height: M 5ST051	 Standfußrahmen 'Edelstahl' Base Frame 'Stainless Steel' 33x33 Höhe/Height: M 3ST101	 Standfußrahmen 'Black Steel' Base Frame 'Black Steel' 33x33 Höhe/Height: M 3ST086
 Standfußrahmen 'Oak' Base Frame 'Oak' 23x23 Höhe/Height: L 5ST086	 Standfußrahmen 'Spruce' Base Frame 'Spruce' 23x23 Höhe/Height: L 5ST054	 Standfußrahmen 'Vintage White' Base Frame 'Vintage White' 23x23 Höhe/Height: L 5ST053	 Standfußrahmen 'Edelstahl' Base Frame 'Stainless Steel' 23x23 Höhe/Height: S 3ST102	 Standfußrahmen 'Black Steel' Base Frame 'Black Steel' 23x23 Höhe/Height: S 3ST087
 Standfußrahmen 'Oak' Base Frame 'Oak' 23x23 Höhe/Height: S 5ST087	 Standfußrahmen 'Spruce' Base Frame 'Spruce' 23x23 Höhe/Height: M 5ST056	 Standfußrahmen 'Vintage White' Base Frame 'Vintage White' 23x23 Höhe/Height: M 5ST055	 Standfußrahmen 'Edelstahl' Base Frame 'Stainless Steel' 23x23 Höhe/Height: L 3ST103	 Standfußrahmen 'Black Steel' Base Frame 'Black Steel' 23x23 Höhe/Height: L 3ST072
 Kunststoffeinsatz Plastic Insert 33x33 3EI057 23x23 3EI055	 Dekor-Metallplatte für Buffet Bowl 23x23 Decoration Steel Frame for Buffet Bowl 23x23 Maxi Anthrazit 3EI081 Stainless Steel 3EI112 Medium Anthrazit 3EI080 Stainless Steel 3EI111	 Dekor-Metallplatte mit Kunststoffeinsatz für Buffetschale 23x23 und Rundplatte 23x23 Decoration Steel Frame with Plastic Insert for Buffet Bowl 23x23 and Round Plate 23x23 Anthrazit RB 591 Stainless Steel RB 592	 Standfußrahmen 'Edelstahl' Base Frame 'Stainless Steel' 23x23 Höhe/Height: M 3ST104	 Standfußrahmen 'Black Steel' Base Frame 'Black Steel' 23x23 Höhe/Height: M 3ST073
 Kühlkissen Cooling Cushion 33x33 / GN 3KU010 23x23 3KU014			 Standfußrahmen 'Edelstahl' Base Frame 'Stainless Steel' 23x23 Höhe/Height: S 3ST144	 Standfußrahmen 'Black Steel' Base Frame 'Black Steel' 23x23 Höhe/Height: S 3ST145
 Abdeckhaube für Rundplatte 23x23 inkl. Edelstahlgriff Cover Hood for Round Plate 23x23 incl. St/St Knob EB 583 E	 Metallkorb für Obstkorb 33x33 Metal Basket for Fruit Basket 33x33 3KO003	 Metallkorb für Zutaten-Display 33x33 Metal Basket for Condiment Display 33x33 3KO019	 Korb, Kunststoff für Brotkorb 33x33 Plastic Basket for Bread Basket 33x33 grau/grey 3KO021 beige 3KO020	 Korb, Kunststoff für Brotkorb 23x23 Plastic Basket for Bread Basket 23x23 grau/grey 3KO008 beige 3KO007
 Edelstahlschale für Getränke-Set 33x33 Stainless Steel Dish for Beverage Set 33x33 3EI087	 Edelstahlschale für Getränke-Set 23x23 Stainless Steel Dish for Beverage Set 23x23 3EI088	 Kühlrippe für Getränke-Set 33x33 Cooling Fin for Beverage Set 33x33 3KU012	 Kühlrippe für Getränke-Set 23x23 Cooling Fin for Beverage Set 23x23 3KU013	 Bügelflasche für Getränke-Set Flip-Top Bottle for Beverage Set 3GL020
 Porzellanplatte für Frischeplatte 33x33 China Plate for Freshness Plate 33x33 weiß/white 3PO027 blau/blue 3PO055 rot/red 3PO122 grau/grey 3PO057 caramel/caramel 3PO058	 Porzellanplatte für Frischeplatte 23x23 China Plate for Freshness Plate 23x23 weiß/white 3PO030 blau/blue 3PO059 rot/red 3PO123 grau/grey 3PO061 caramel/caramel 3PO062	 Porzellanschale für Frischeschale 33x33 China Dish for Freshness Dish 33x33 weiß/white 8PO005 blau/blue 3PO131 rot/red 3PO132 grau/grey 3PO133 caramel/caramel 3PO134	 Porzellanschale für Frischeschale 23x23 China Dish for Freshness Dish 23x23 weiß/white 3PO135 blau/blue 3PO136 rot/red 3PO137 grau/grey 3PO138 caramel/caramel 3PO139	































 Porzellankugel 3,5 Liter inkl. Deckel für Buffet Bowl Maxi 23x23 China Bowl incl. Lid for Buffet Bowl Maxi 23x23 weiß/white RB 569 blau/blue RB 586 rot/red RB651 grau/grey RB 588 caramel/caramel RB 589	 Porzellankugel 1,5 Liter inkl. Deckel für Buffet Bowl Medium 23x23 China Bowl incl. Lid for Buffet Bowl Medium 23x23 weiß/white RB 568 blau/blue RB 582 rot/red RB652 grau/grey RB 584 caramel/caramel RB 585	 Porzellanschale für Buffetschale 23x23 China Bowl for Buffet Bowl 23x23 weiß/white 3PO008 blau/blue 3PO079 rot/red 3PO128 grau/grey 3PO081 caramel/caramel 3PO082	 Porzellanplatte für Rundplatte 23x23 China Plate for Round Plate 23x23 weiß/white 3PO020 blau/blue 3PO083 rot/red 3PO129 grau/grey 3PO085 caramel/caramel 3PO086	
 Glascontainer mit Bügelverschluss Glass Container with Flip-Top Lid Barrel 'Classic', 5 Liter 3GL023 Barrel 'Classic', 8 Liter 3GL024	 Universaladapter für Montage des FRILICH Zapfhahnes Universal Adapter for FRILICH Faucet assembling RB 708	 Dekorplatte für Glascontainer Decor Frame for Glass Container Stainless Steel RB 714	 Eisschale für Glascontainer Ice Insert for Glass Container 3EI105	
 Edelstahlhahn, komplett Stainless Steel Faucet, complete BB 803 E	 Hahnkörper (Edelstahlhahn) Faucet Body (Stainless Steel Faucet) 3HA020	 Haube, Griff (Edelstahlhahn) Cap, Handle (Stainless Steel Faucet) 3HA019	 Kühlakku Cooling Pack 3KU007	
 Scheibendichtung für Zapfhähne Disc Shaped Washer for Faucets 3DI002	 Eisschale für Frischeplatte GN Ice Insert for Freshness Plate GN 3EI117			
ACE OF VASE				
 Saftzylinderröhre Juice Cylinder Tube 3BE022	 Edelstahlhahn, komplett Stainless Steel Faucet, complete BB 803 E	 Hahnkörper (Edelstahlhahn) Faucet Body (Stainless Steel Faucet) 3HA020	 Haube, Griff (Edelstahlhahn) Cap, Handle (Stainless Steel Faucet) 3HA019	 Edelstahldeckel Stainless Steel Lid 3DE116
 Eisschale für Saftzylinderröhre Ice Insert for Juice Cylinder Tube 3EI120	 Scheibendichtung für Zapfhähne Disc Shaped Washer for Faucets 3DI002	 Kühlakku Cooling Pack 3KU007	 Standfuß 'Uno' Stand 'Uno' 5ST082	 Standfuß 'Duo' Stand 'Duo' 5ST083
 Universaladapter für Montage des FRILICH Zapfhahnes Universal Adapter for FRILICH Faucet assembling RB 708	 Tropfschale und Tropfgitter Drip Tray and Drip Dish RB 907 E			

CARAFINE

-  **Crasheisröhre für Triplet und Quintet**
Edelstahl
Crushed Ice Tube for Triplet and Quintet
Stainless Steel
3CR011
-  **Kühlakku (einzeln)**
Cooling Pack for Solo (single)
3KU011
-  **Kratzschutz, Kunststoff (schwarz) für Solo**
Scratch Guard, plastic (black) for Solo
3ME025
-  **Kunststoffeinsatz Trio**
Plastic Inset Trio
5E1012
-  **Rahmeneinsatz Septet**
Support Frame Septet
5ME005
-  **Edelstahl Tropfschale Crystal**
Stainless Steel Drip Tray Solo Crystal
3TS035
-  **Kunststoffeinsatz Septet**
Plastic Inset Septet
5E1011
-  **Kunststoffeinsatz Solo**
Plastic Inset Solo
5E1013
-  **Isolierter Standfuß poliert mit drei Kühlakkus im Edelmantel**
Insulated Base including cooling packs and stainless steel shell
Edelstahl / Stainless Steel
EB 632 E
Gold / Gold
EB 632 G
-  **Edelstahldeckel für Karaffe 1,2 Liter**
Stainless steel Lid for Carafe 1.2 liters
3ME020
-  **Silikonstopfen für Milchflasche, 1,0 Liter**
Silicone Plug for Milk-Bottle 1,0 Liters
3DE097
-  **Kunststoffkaraffe, 1,2 Liter**
Plastic Carafe, 1,2 Liters
3BE009
-  **Bügelflasche, 1,0 Liter**
Swing-Top Bottle, 1,0 Liters
3GL021
-  **Porzellankaraffe, 1,2 Liter**
China Carafe, 1,2 Liters
3PO039
-  **Glaskaraffe, 1,2 Liter**
Glass Carafe, 1,2 Liters
3GL007
-  **Glasflasche mit Milchmotiv, 1,0 Liter**
Glass Bottle with Milk Motif, 1,0 Liters
3GL022

ELEGANCE Saft- und Milchkannen · Juice and Milk Dispenser

-  **Edelstahlhahn, komplett**
Stainless Steel Faucet, complete
BB 803 E
-  **Hahnkörper (Edelstahlhahn)**
Faucet Body (Stainless Steel Faucet)
3HA020
-  **Haube, Griff (Edelstahlhahn)**
Cap, Handle (Stainless Steel Faucet)
3HA019
-  **Non-Drip Hahn, komplett**
Modell Edelstahl
Non-Drip Faucet, complete
Model Stainless Steel
BB 802 E
-  **Scheibendichtung**
Disk shaped washer
3DI002
-  **Saftzylinder, Acrylglas 9 Liter**
Juice Container, acrylic glass 9 liters
3PL035
-  **Saftzylinder Aktiv, 5 Liter**
spülmaschineneeignet, mit Aluboden
Juice Container Aktiv, 5 liters
dishwasher-proof, with aluminium bottom
3SA051 transparent
3SA052 opal/translucent
-  **Eisbehälter für Saftkanne/Milchkanne**
Ice Inset for Juice and Milk Dispenser
für 2,5 l Saft / 3 l Milch
for 2.5 l Juice / 3 l milk
3E1012
-  **Kühlakku für Saft- und Milchkanne**
Cooling Pack for Juice and Milk Dispenser
3KU007
-  **Zylinderdichtung**
Cylindrical Washer
1DI002
-  **Milchkanne ohne Deckel, Edelstahl**
Milk Can without lid, Stainless Steel
3 Liter / 3 liters
3KA008
5 Liter / 5 liters
3KA006
-  **Saftzylinder spülmaschineneeignet**
Juice Container dishwasher-proof
für 2,5 l Saft / for 2.5 l Juice
3SA037 transparent
3SA047 opal/translucent
für 5 l Saft / for 5 l Juice
3SA011 transparent
3SA046 opal/translucent
-  **Crasheisröhre, Edelstahl, für Saftkanne**
Crushed Ice Tube, st. st., for Juice Dispenser
2,5 Liter / 2.5 liters
3CR006
5 Liter / 5 liters
3CR007
-  **Crasheisröhre, Edelstahl, für Milchkanne**
Crushed Ice Tube, st. st., for Milk Can
3 Liter / 3 liters
3CR001
5 Liter / 5 liters
3CR002
-  **Edelstahldeckel für Milchkanne**
Stainless Steel Lid for Milk Can
3 Liter / 3 liters
3DE025 Edelstahl/St. St.
3DE029 Gold
5 Liter / 5 liters
3DE011 Edelstahl/St. St.
3DE008 Gold

-  **Edelstahldeckel für Saftkanne (ohne Griff)**
Stainless Steel Lid for Juice Dispenser (without knob)
2,5 Liter / 2.5 liters
3DE063 Edelstahl/St. St.
3DE064 Gold
5 Liter / 5 liters
3DE065 Edelstahl/St. St.
3DE066 Gold
-  **Deckel für Saftkanne 9 l, Acrylglas (ohne Griff)**
Lid for Juice Dispenser 9 liters, acrylic glass (without lid)
3DE049
-  **Edelstahl-Tropfschale für Saftkanne/Milchkanne**
Stainless Steel Drip Dish for Juice and Milk Dispenser
für 2,5 Liter Saft / Milch
for 2.5 liter Juice / milk
3TS023
für 5 Liter Saft / Milch
for 5 liters Juice / milk
3TS024
-  **Tropfschale für Saftkanne 9 Liter, Acrylglas (transparent)**
Drip Dish for Juice Dispenser 9 liters, acrylic glass (transparent)
3TS021
-  **Tropfgitter Drip Grille**
Edelstahl/St. St.
3TB012
Edelstahl/St. St.
3TB013 Gold
-  **Tropfgitter für Saftkanne 9 Liter**
Drip Grille for Juice Dispenser 9 liters
3TB003 Edelstahl/St. St.
3TB011 Gold
-  **Griff (inkl. Deckelhalterung)**
Knob (incl. lid holder)
für 2,5 l Saft / 5 l Saft
for 2.5 l Juice / 5 l Juice
EB 591 E Edelstahl/St. St.
EB 591 G Gold
-  **Griff für Saftkanne 9 Liter (Zylindergriffe, seitlich)**
Knob for Juice Dispenser 9 liters (knobs, lateral)
BB 576 E Edelstahl/St. St.
BB 576 G Gold
-  **Griff für Saftkanne 9 Liter (Deckel)**
Knob for Juice Dispenser 9 liters (Lid)
BB 577 E Edelstahl/St. St.
BB 577 G Gold
-  **Netzgerät für Rührdeckel**
Power supply unit for Stirring Lid
3RU015
-  **Netzgerät für Kühleinheit Aktiv**
Power supply for Cooling Unit Milk Can Aktiv
3NO040
-  **Edelstahldeckel Twin**
Stainless Steel Lid Twin
3DE095
-  **Verbindungskabel Aktiv**
Connecting cable Aktiv
3RU026
-  **Tropfschale Twin**
Drip Dish Twin
3TS034
-  **Saftzylinder 4 l Twin**
Juice Container Twin 4 l
3SA054
-  **Saftzylinder 5 l Twin**
Juice Container Twin 5 l
3SA055
-  **Eisbehälter Twin**
Ice Inset Twin
8E1001
-  **Crasheisröhre Twin, Edelstahl**
Crushed Ice Tube Twin, Stainless Steel
3CR010
-  **Porzellan Behälter 0,6 Liter**
China Cup, 0.6 liters
3PO040
-  **Kunststoffbehälter (opal) 0,6 Liter**
Plastic Pot (translucent) 0.6 liters ea.
3SA053
-  **Edelstahldeckel für Jam Pot (ohne Griff)**
Stainless Steel Lid for Jam Pot (without knob)
3DE078 Edelstahl/St. St.
3DE079 Gold
-  **Griff incl. Halterung**
Knob incl. Lid holder
EB 591 E Edelstahl/St. St.
EB 591 G Gold
-  **Deckelhalterung für Jam Pot**
Lid Holder for Jam Pot
3DE044
-  **Gute-Nacht-Deckel für Jam Pot**
Good-Night Lid for Jam Pot
3SA017
-  **Müsliflöte 1,5 Liter**
Flute 1.5 liters
3SA015
-  **Druckdeckel für Müsliflöte**
Press-on Lid for Muesli Flute
3DE054 Edelstahl/St. St.
3DE055 Gold
-  **Gute Nacht Deckel für Müsliflöte**
Good Night Lid for Muesli Flute
3DE056
-  **Glasschälchen 60 mm**
Glass Bowl 60 mm
3GL003
-  **Dosierventil Honigspender**
Dosage Valve for Honey Holder
3HO020
-  **Kunststoffbehälter für Honigspender**
Plastic Pot for Honey Holder
3HO019
-  **Edelstahltropfschälchen**
Drip Tray in St. St.
4TS001

ELEGANCE Konfitürenbars, Honigspender, Müslibars, Schälchenhalter · Jam Bars, Honey Holder, Muesli Bars, Bowl Holder

ELEGANCE Brotplatte · Bread Tray

 Holzplatte für Brotschale
Wooden Tray
3EI068

ELEGANCE Butterschale, Frischeschale, Buffet Bowl · Butter Dish, Freshness Dish, Buffet Bowl

 Eisbehälter für Frischeplatte GN
Ice Inset for Freshness Dish
3EI027

 Kühlakku für Butterschale / Frischeschale
Cooling Pack for Butter / and Freshness Dish
3KU007

 Kühlakku für 'Buffet Bowl'
Cooling Pack for 'Buffet Bowl'
8KU006

 Kunststoff-Dekoring für 'Buffet Bowl'
Plastic Decoration Ring for 'Buffet Bowl'
8ME031

 Deckel für 'Buffet Bowl' ohne Griff
Lid for 'Buffet Bowl' without Knob
8DE025

 Edelstahlinsatz für Butterschale
Stainless Steel Inset for Butter Dish
3EI008

 Griff inkl. Halterung
Knob incl. Lid Holder
EB 591 E Edelstahl/St. St.
EB 591 G Gold

 Deckel
Lid
3DE076 Edelstahl/St. St.
3DE077 Gold

UNISON

 Rolltop-Haube ohne Griff für '400'
Rolltop Hood without knob for '400'
10006

 Rolltop-Haube ohne Griff für 'GN'
Rolltop-Hood without knob for 'GN'
10011

 Griff für '400 / GN'
Knob for '400 / GN'
EB 590 E Edelstahl/St. St.
EB 590 G Gold

 Griff für Cool '300 / 280'
Knob for '300 / 280'
EB 589 E Edelstahl/St. St.
EB 589 G Gold

 Abdeckhaube ohne Griff für '230'
Cover Hood without knob for '230'
3DE075

 Abdeckhaube ohne Griff für '300'
Cover Hood without Knob for '300'
3DE035

 Abdeckhaube ohne Griff für '280'
Cover Hood without knob for Freshness Dish '280'
3DE069

 Aufstellarm für '300'
Hinged Hood Device for '300'
EB 569 E Edelstahl/St. St.
EB 569 G Gold

 Kühlkissen
Cooling cushion
3KU014

 Eisbehälter für Frischeplatte '300'
Ice Inset for Freshness Plate '300'
3EI029

 Eisbehälter für Frischeplatte '400'
Ice Inset for Freshness Plate '400'
3EI030

 Eisbehälter für Frischeplatte GN
Ice Inset for Freshness Plate GN
3EI027

 Eisbehälter für Frischeplatte 230, 280
Ice Inset 230, 280
3EI028

CONNECT

 Edelstahlröhre für 'Juicer'
Stainless Steel Tube for 'Juicer'
3GE007

'Juicer' Acrylröhre
'Juicer' Acrylic Container
3PL051 3l
3PL052 4l

 Eiseinsatz für 'Juicer'
Edelstahl
Ice Inset for 'Juicer'
Stainless Steel
3EI094

 Kühlakku für 'Juicer'
Cooling Pack for 'Juicer'
3KU015

 Edelstahlhahn, komplett
Stainless Steel Faucet, complete
BB 803 E

 Hahnkörper (Edelstahlhahn)
Faucet Body (Stainless Steel Faucet)
3HA020

 Haube, Griff (Edelstahlhahn)
Cap, Handle (Stainless Steel Faucet)
3HA019

 Scheibendichtung
Disk shaped Washer
3DI002

 Edelstahlröhre für 'Hopper'
Stainless Steel Tube for 'Hopper'
3GE004

'Hopper' Acrylröhre
'Hopper' Acrylic Container
3PL038 2,5l
3PL039 3,5l
3PL047 4,5l

 Edelstahlschütze für 'Hopper'
Stainless Steel Shut for 'Hopper'
3ME033

'Hopper' Paddel aus Silikon
'Hopper' Paddle made of silicone
3ME031

 Drehknopf, Edelstahl mit Steckachse
Stainless Steel Turning Knob with floating axle
3ME032

 Edelstahldeckel für 'Hopper' und 'Juicer'
Stainless Steel Lid for 'Hopper' and 'Juicer'
3DE094

 Edelstahldeckel für Karaffe 1,2 Liter
Stainless steel Lid for Carafe 1.2 liters
3ME020

 Kunststoffeinsatz für 'connect' Standfuß
Plastic Inset for 'connect' base
3EI093

 Porzellanbehälter 0,6 Liter
China Cup 0.6 liters
3PO040

 Kunststoffbehälter (opal) 0,6 Liter
Plastic Pot (translucent) 0.6 liters
3SA053

 Edelstahldeckel für Jam Pot (ohne Griff)
Stainless Steel Lid for Jam Pot (without knob)
3DE078 Edelstahl/St. St.
3DE079 Gold

 Griff incl. Halterung für Jam Pot
Knob for Jam Pot incl. Lid holder
EB 591 E Edelstahl/St. St.
EB 591 G Gold

 Gute-Nacht-Deckel für Jam Pot
Good-Night Lid for Jam Pot
3SA017

 Müsliflöte 1,5 Liter
Flute 1.5 liters
3SA015

 Druckdeckel
Press-on Lid
3DE054 Edelstahl/St.
3DE055 Gold

 Gute Nacht Deckel für Müsli Flöte
Good Night Lid for Muesli Flute
3DE056

 Deckelhalterung, Jam Pot
Lid Holder, Jam Pot
3DE044

 Glaskaraffe 1,2l
Glass Carafe 1.2l
3GL007

 Porzellankaraffe 1,2l
China Carafe 1.2l
3PO039

 Kunststoffkaraffe 1,2l
Plastic Carafe 1.2l
3BE009

PICKNICK / EARTH

 Abdeckhaube ohne Griff '300'
Cover Hood without Knob '300'
3DE035

 Abdeckhaube ohne Griff '400'
Cover Hood without Knob '400'
3DE098

 Aufstellarm für '300 Schale'
Hinged Hood Device for '300 Dish'
EB 643 E

 Aufstellarm für '400 Schale'
Hinged Hood Device for '400 Dish'
EB 642 E

 Kühlkissen für '300 Schale'
Cooling cushion for '300 Dish'
3KU017

 Standfuß aus Speckstein für '300 Schale'
Base made of Soapstone for '300 Dish'
3ST156

 Standfuß aus Speckstein für '400 Platte'
Base made of Soapstone for '400 Plate'
3ST152

 Standfuß aus Weidekorb, (Kunststoff) spülmaschineneeignet '300 Schale'
Base made of Wicker Basket (Plastic), dishwasher proof '300 Dish'
3KO010 (beige)
3KO015 (grau/grey)

 Standfuß aus Weidekorb, (Kunststoff) spülmaschineneeignet '400 Platte'
Base made of Wicker Basket (Plastic), dishwasher proof '400 Plate'
3KO009 (beige)
3KO014 (grau/grey)

 Kühlkissen für '400 Schale'
Cooling cushion for '400 Dish'
3KU016

 Griff / Knob
EB 589 E

PURE NATURE

 Tropfschale und Tropfgitter
Drip Tray and Drip Dish
RB 907 E

 Milchkanne ohne Deckel, Edelstahl
Milk Can without lid, Stainless Steel
3 Liter / 3 liters
3KA008
5 Liter / 5 liters
3KA006

 Edelstahldeckel für Milchkanne
Stainless Steel Lid for Milk Can
3 Liter / 3 liters
3DE025 Edelstahl / St. St.
5 Liter / 5 liters
3DE011 Edelstahl / St. St.

 Eiseinsatz, Milchkanne für 3 Liter / for 3 liters
3EI044
für 5 Liter / for 5 liters
3EI045

 Eiseinsatz für Frischeschale
Ice Inset for Freshness Dish
6EI001

 Holzstandfuß für 'Bowl Bar' Buche hell
Wooden Base for 'Bowl Bar' Natural Beech
'Bowl Bar S'
RB 603 X
'Bowl Bar M'
RB 602 X
'Bowl Bar L'
RB 601 X

 Holzstandfuß für Milchkanne Buche hell
Wooden Base for Milk Can Natural Beech
für 3 Liter / for 3 liters
3ST134
für 5 Liter / for 5 liters
3ST131







 Holzstandfuß für Frischeschale Buche hell
Wooden Base for Freshness Dish Natural Beech
'Single S'
3ST062
'Single L'
3ST061

 Kühlakku
Cooling Pack
3KU007

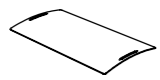











B-LINIE

- | | | | | |
|--|--|---|--|---|
|  <p>Milchkanne ohne Deckel, Edelstahl
Milk Can without lid, Stainless Steel</p> <p>3 Liter / 3 liters
3KA008
5 Liter / 5 liters
3KA006</p> |  <p>Edelstahldeckel für Milchkanne
Stainless Steel Lid for Milk Can</p> <p>3 Liter / 3 liters
3DE025
5 Liter / 5 liters
3DE011</p> |  <p>Saftzylinder, spülmaschineneignend
Juice Container, dishwasher proof</p> <p>2,5 Liter / 2.5 liters
3SA037
5 Liter / 5 liters
3SA011</p> |  <p>Kunststoffdeckel ohne Griff für Saftkanne
Plastic Lid without Knob for Juice Dispenser</p> <p>2,5 Liter / 2.5 liters
3SA025
5 Liter / 5 liters
3SA002</p> |  <p>Kugelgriff, Kunststoff verchromt für Saftkanne
Chromed Knob, plastic for Juice Dispenser</p> <p>XB 515 E</p> |
|  <p>Scheibendichtung
Disc Shaped Washer</p> <p>3DI 002</p> |  <p>Non-Drip-Hahn, Kunststoff, schwarz
Non-Drip Faucet, black Polysterene</p> <p>XB 802 K</p> |  <p>Tropfgitter für Milch- und Saftkanne
Drip Grille for Juice and Milk Dispenser</p> <p>3TB012</p> |  <p>Kunststofftropfschale schwarz
Drip Tray made of plastic, black</p> <p>2,5 Liter Saft / 3 Liter Milch
2,5 liters juice / 3 liters milk
3TS027</p> <p>5 Liter Saft / 5 Liter Milch
5 liters juice / 5 liters milk
3TS036</p> |  <p>Kunststoffbehälter (opal), 0,6 Liter
Plastic Pot (translucent)</p> <p>2,6 Liter / 0.6 liters
3SA053</p> |
|  <p>Kunststoffdeckel ohne Griff für Konfitürenbehälter
Plastic Lid without Knob for Jam Pot</p> <p>3SA016</p> |  <p>Müsliflöte 1,5 Liter ohne Deckel
Muesli Flute 1.5 liters without Lid</p> <p>3SA015</p> |  <p>Kunststoffdeckel für Müsliflöte, grau
Plastic Lid for Muesli Flute, grey</p> <p>Z06 6930</p> | | |

HYGIENESCHUTZ / HYGIENIC COVER

- | | | |
|--|---|--|
|  |  <p>Acrylglas-Haube für Hygieneschutz Raisersystem
Acrylic Glass Board for hygienic cover for raiser system</p> <p>EB 718 K</p> |  <p>Acrylglas-Haube für Hygieneschutz Cool GN
Acrylic Glass Board for hygienic cover Cool GN</p> <p>EB 717 K</p> |
|  |  <p>Acrylglas-Haube für Hygieneschutz Cool 400
Acrylic Glass Board for hygienic cover Cool 400</p> <p>EB 716 K</p> |  <p>Acrylglas-Haube für Hygieneschutz Cool 300
Acrylic Glass Board for hygienic cover Cool 300</p> <p>EB 715 K</p> |
| |  <p>Füße für Hygieneschutz (2 Stück) für Höhe 390 mm
Stands for hygienic cover (2 pieces) for height 390 mm</p> <p>EB 704</p> |  <p>Füße für Hygieneschutz (2 Stück) für Höhe 600 mm
Stands for hygienic cover (2 pieces) for height 600 mm</p> <p>EB 711</p> |

GASTRO

- | | | | | |
|---|--|--|---|---|
|  <p>Tropfgitter, rechteckig
Drip Grille, rectangular</p> <p>1TB004</p> |  <p>Kunststofftropfschale, rechteckig
Plastic Drip Tray</p> <p>1EI002</p> |  <p>Kühlakku
Cooling Pack'</p> <p>3KU007</p> |  <p>Tropfgitter, rund
Drip Tray, round'</p> <p>1TS020</p> |  <p>Edelstahlhahn, komplett
Stainless Steel Faucet, complete'</p> <p>BB 803 E</p> |
|  <p>Hahnkörper (Edelstahlhahn)
Faucet Body (Stainless Steel Faucet)'</p> <p>3HA020</p> |  <p>Haube, Griff (Edelstahlhahn)
Cap, Handle (Stainless Steel Faucet)'</p> <p>3HA019</p> |  <p>Scheibendichtung
Disc shaped Washer</p> <p>3DI002</p> |  <p>Edelstahlbehälter 2 Liter
Stainless Steel Container 2 liters</p> <p>1BE023</p> |  <p>Edelstahldeckel für Edelstahlbehälter Milch
Stainless Steel Lid for Stainless Steel Container Milk</p> <p>1DE009</p> |
|  <p>Edelstahldeckel für Zuckerbehälter
Stainless Steel Lid for Sugar Container</p> <p>1DE028</p> |  <p>Kunststoffbehälter für Streuzucker
Plastic Container for Granulated Sugar</p> <p>1SA001</p> | | | |

FRILICH Buffetplaner auf www.frilich.com

Vorhandene Tischflächen optimal mit dem benötigten Buffetangebot ausstatten oder für ein benötigtes Buffetangebot die optimale Buffetfläche gestalten: Mit dem FRILICH Buffetplaner haben Sie hierfür ab sofort eine Gestaltungshilfe, die Ihnen unter www.frilich.com zur Verfügung steht. Dieses Modul unterstützt Sie in sieben Schritten bei der Planung und Einrichtung eines perfekt kombinierten und effizient in Szene gesetzten Buffets.

- 2 Komponenten:** Wählen Sie aus den FRILICH Buffetlinien die Produkte aus, die Sie auf Ihrem Buffet platzieren möchten. Beachten Sie, dass Ihnen unterschiedliche Buffetdesigns zur Verfügung stehen, die Ihnen die Gestaltung nach individuellen Vorstellungen möglich macht. Sobald Sie das von Ihnen ausgewählte Produkt anklicken, erscheint dieses zur Positionierung auf der zuvor bemaßten Tischskizze. Unter dem Menüpunkt 'Sonstiges' können auch Buffetprodukte selbst definiert und bemaßt werden, die nicht im FRILICH Sortiment enthalten sind.

Components: Choose from the various FRILICH product lines, which items you wish to place on your buffet table. Please note that you may select different buffet designs to make an arrangement according to your individual needs and ideas. When you select a particular product from the left hand side of the components list, it will appear for positioning on the pre-selected table area. You can also reserve space for your own products on the table layout, by selecting the menu item 'Other' (last item under the heading 'Components').

- 1 Tisch:** Zur Auswahl steht Ihnen die Gestaltung eines runden/ovalen oder eines rechteckigen Buffettisches. Bestimmen Sie Breite und Tiefe in Millimeter. Eine maßstabstreue Tischskizze wird zur Bestückung des Buffets auf Ihrem Bildschirm dargestellt.

Table: You may choose or select a rectangular, round or oval table. Fill in the dimensions box and then click OK. A true to scale image of your table will be generated and shown on the screen.

FRILICH Buffet Planner at www.frilich.com

Equip existing table layout area with the required buffet items or calculate the required space for your buffet display products. The FRILICH buffet planner offers a presentation tool, which is available to use at www.frilich.com. This module assists you in planning and setting up a perfect matching combination – seven steps to create your individual buffet.

- 3 Platzieren und Drehen auf der Tischskizze:** Die von Ihnen ausgewählten Produkte erscheinen auf dem Tisch als Strichzeichnung in Vogelperspektive. Positionieren und drehen Sie mit Hilfe der Maus das Produkt auf der Tischskizze. Achten Sie auf die Höhenmaße der Produkte. Damit Ihre Produktplatzierung anwenderfreundlich bleibt, werden z.B. niedrigere vorne und höhere Buffetprodukte dahinter platziert.

Placing and rotating items on the table sketch/image:

The products that you have selected appear from a bird's eye view and in the form of line drawings. You can move and rotate the selected 'part' by clicking on the green navigation buttons, which will appear when you move the arrow cursor/mouse over the drawing. Please note the height dimension of the articles. In order to provide a user-friendly product placement, small buffet items are placed in the front with the bigger items arranged behind.

- 6 Stückliste/Alles entfernen/Druck:** Wenn Sie Ihr Buffet fertig gestaltet haben, können Sie die Stückliste nochmal separat als Druckliste aufrufen. Für einen 2. Versuch lässt sich die Liste aber auch noch einmal komplett entfernen.

Parts list/Remove all/Print: Part List / Remove all / Print After arranging your buffet, you can again separately access the parts list for printing. You can also remove items individually at any time and start again.

- 7 Anfrage senden:** Die Buffetprodukte sind platziert, der Präsentationstisch optimal von Ihnen ausgestattet. Bestätigen Sie mit dem Button 'Anfrage senden' und FRILICH erhält automatisch die Produktliste zur Erstellung Ihres Angebotes. Selbstverständlich stets unverbindlich!

Request a quote: The buffet items are placed and you have optimally equipped the table area. By clicking on the 'Request a Quote' button, the FRILICH team or one of our sales partners will submit an offer of the items chosen by you in the parts list. Of course the sales quote is without any commitment.

- 5 Stückliste (Optionen):** Die Stückliste ermöglicht Ihnen Ihre Produktwahl weiter zu präzisieren. Entscheiden Sie, ob das Produkt in der Ausführung 'Gold' gelistet werden soll. Oder möchten Sie das FRILICH Kühlkissensystem zur ausgewählten Servierplatte hinzufügen?

Parts list (Options): On some products you will be able to select further options i. e. product choice.

Item No.	Product Name	Image
1.	RB 609 E 003 pure nature - Servierplatte mit Porzellanplatte voll, S Edelstahl-Raiser Höhe 80 mm, Breite 310 mm, Tiefe 310 mm Optionen: <input type="checkbox"/> Optional: Kühlkissen-Set (Art.: RB 560)	
2.	RB 624 E 002 pure nature - Buffet Bowl 1,5 Liter, M Edelstahl-Raiser Höhe 280 mm, Breite 210 mm, Tiefe 210 mm	
3.	RB 623 E 001 pure nature - Buffet Bowl 3,5 Liter, L Edelstahl-Raiser Höhe 385 mm, Breite 210 mm, Tiefe 210 mm	

- 4 Stückliste:** Ausgewählte Produkte werden in die Stückliste aufgenommen. Artikelnummer, Produktbeschreibung und weitere Details zu Ihrer Auswahl stehen Ihnen in dieser Liste zur Verfügung.

Parts list: All the selected products will be included in a 'Parts List' together with item code, detailed description and product pictures.



Katalog 10 Artikelliste / List of Articles

Artikel Nr.	Seite/page	Artikel Nr.	Seite/page	Artikel Nr.	Seite/page	Artikel Nr.	Seite/page	Artikel Nr.	Seite/page
10006	110	3EI088	106	3PO059	106	3ST086	106	9DE003	104
10011	110	3EI093	111	3PO061	106	3ST087	106	9DE004	104
10078	68, 95	3EI094	110	3PO062	106	3ST100	106	9DE005	104
EB 547 E	36	3EI105	107	3PO079	107	3ST101	106	9DE006	104
10078	70	3EI111	106	3PO081	107	3ST102	106	9DE007	104
10079	70	3EI112	106	3PO082	107	3ST103	106	9DE008	104
1BE023	113	3EI117	107	3PO083	107	3ST104	106	9DE010	104
1DE009	113	3EI120	107	3PO085	107	3ST109	96	9DE011	104
1DE028	113	3GE004	110	3PO086	107	3ST110	96	9DE013	104
1DI002	108	3GE007	110	3PO099	68	3ST125	94	9DE014	104
1EI002	113	3GL003	78, 109	3PO100	68	3ST126	94	9DE015	104
1ME015	98	3GL007	108, 111	3PO102	68	3ST127	94	9DE016	104
1ME016	98	3GL020	106	3PO103	68	3ST131	111	9DE017	104
1ME018	98	3GL021	30, 108	3PO104	68	3ST134	111	9DE018	104
1ME022	98	3GL022	108	3PO105	68	3ST144	106	AB 100 E	23
1ME023	98	3GL023	107	3PO107	68	3ST145	106	AB 513	70
1SA001	113	3GL024	107	3PO108	68	3ST152	111	ASC 100 H	23
1TB004	113	3HA019	107, 108, 110, 113	3PO109	68	3ST156	111	ASC 200 H	23
1TS020	113	3HA020	107, 108, 110, 113	3PO110	68	3ST160	94	ATO 300 T	89
3BE002	76	3HO019	109	3PO112	68	3ST161	94	BB 100	86
3BE003	76	3HO020	109	3PO113	68	3ST162	94	BB 101	86
3BE005	28	3KA006	108, 111, 112	3PO114	68	3TB003	109	BB 506 E	37
3BE007	28	3KA008	108, 111, 112	3PO115	68	3TB011	109	BB 506 G	37
3BE009	111	3KO003	106	3PO117	68	3TB012	109, 112	BB 549 E	36
3BE010	31	3KO007	106	3PO118	68	3TB013	109	BB 549 G	36
3BE015	28	3KO008	106	3PO122	106	3TS016	109	BB 576 E	109
3BE017	28	3KO009	111	3PO123	106	3TS023	109	BB 576 G	109
3CR001	108	3KO010	111	3PO124	68	3TS027	112	BB 577 E	109
3CR002	108	3KO014	111	3PO125	68	3TS034	109	BB 577 G	109
3CR006	108	3KO015	111	3PO126	68	3TS035	108	BB 802 E	108
3CR007	108	3KO019	106	3PO127	68	3TS036	112	BB 803 E	107, 108, 110, 113
3CR010	109	3KO020	106	3PO128	107	3ZU001	105	BSC 090 E	36
3CR011	108	3KO021	106	3PO129	107	3ZU007	105	BSC 090 G	36
3DE002	107	3KO023	101	3PO131	106	3ZU024	103	BTO 006 H	87
3DE008	108	3KU007	107, 108, 110, 111, 113	3PO132	106	3ZU026	33, 41, 102	BTO 014 H	87
3DE009	108	3KU010	106	3PO133	106	3ZU037	105	BTO 120 H	86
3DE011	108, 111, 112	3KU011	108	3PO134	106	3ZU038	105	BTO 170 H	86
3DE025	108, 111, 112	3KU012	106	3PO135	106	3ZU039	105	DB 025	100
3DE029	108	3KU013	106	3PO136	106	3ZU040	105	DB 045	98
3DE035	110, 111	3KU014	106, 110	3PO137	106	3ZU041	105	DB 051	99
3DE044	109, 111	3KU015	110	3PO138	106	3ZU042	105	DB 052	99
3DE049	109	3KU016	111	3PO139	106	3ZU043	105	DB 053	98
3DE054	109, 111	3KU017	111	3RU015	109	3ZU044	105	DB 054	98
3DE055	109, 111	3ME012	108	3SA002	112	3ZU063	102	DB 055	98
3DE056	109, 111	3ME020	111	3SA011	108, 112	4TS001	109	DB 056	101
3DE063	109	3ME025	108	3SA015	109, 111, 112	5EI011	108	DB 057	101
3DE064	109	3ME025	108	3SA016	112	5EI012	108	DFO 002 A 016	100
3DE065	109	3ME031	110	3SA017	109, 111	5EI013	108	DFO 002 A 017	100
3DE066	109	3ME032	110	3SA025	112	5ME005	108	DTO 002 N 003	100
3DE069	110	3ME033	110	3SA028	75	5SC001	30, 102	DVO 020 H	101
3DE075	110	3NO053	109	3SA029	75	5SC002	22, 102	DVO 050 H	101
3DE076	110	3PL035	108	3SA030	74	5SC003	88	EB 502 E	34, 36
3DE077	110	3PL038	110	3SA031	74	5ST049	106	EB 502 E 900	34, 36
3DE078	109, 111	3PL039	110	3SA037	108, 112	5ST050	106	EB 502 G	35, 36
3DE079	109, 111	3PL047	110	3SA046	108	5ST051	106	EB 502 G 900	35, 36
3DE080	76	3PL051	110	3SA047	108	5ST052	106	EB 530 E	111
3DE094	111	3PL052	110	3SA051	108	5ST053	106	EB 541 E	54
3DE095	109	3PL057	87	3SA052	108	5ST054	106	EB 543 E	72
3DE097	108	3PL058	87	3SA053	98, 109, 111, 112	5ST055	106	EB 543 G	72
3DE098	111	3PO001	71	3SA054	109	5ST056	106	EB 545 E	52, 54
3DE116	107	3PO003	71	3SA055	109	5ST082	107	EB 546 E	72
3DI002	107, 108, 110, 112, 113	3PO004	71	3SC330E	103	5ST083	107	EB 546 G	72
3EI 027	110	3PO005	73	3SC330G	103	5ST084	106	EB 547 G	36
3EI008	110	3PO006	73	3SH010	103	5ST085	106	EB 549 E	40, 42
3EI012	108	3PO008	74, 107	3SH011	103	5ST086	106	EB 549 G	42
3EI019	108	3PO020	75, 107	3SH012	103	5ST087	106	8DE025	110
3EI027	110	3PO027	96, 106	3SH013	103	8EI001	109	8K0006	110
3EI028	110	3PO029	96	3ST021	109	8ME031	110	8PL011	24
3EI029	110	3PO030	106	3ST024	109	8PL012	24	8PL013	24
3EI030	110	3PO036	40	3ST061	111	8PL014	24	8PL014	24
3EI044	111	3PO039	108, 111	3ST062	111	8PO005	106	8SH001	103
3EI045	111	3PO040	109, 111	3ST072	106	8SH001	103	9DE001	104
3EI055	106	3PO048	52, 54	3ST073	106	9DE001	104	9DE002	104
3EI057	106	3PO049	52, 54	3ST080	96	9DE002	104	EB 566 G 900	37
3EI068	110	3PO054	105	3ST082	94	9DE002	104		
3EI080	106	3PO055	106	3ST083	94				
3EI081	106	3PO057	106	3ST084	94				
3EI087	106	3PO058	106	3ST085	106				

Artikel Nr.	Seite/page	Artikel Nr.	Seite/page	Artikel Nr.	Seite/page	Artikel Nr.	Seite/page	Artikel Nr.	Seite/page
EB 569 E	110	EFC 015 G 002	75	F01.101.0002	57	F02.300.0002	58	F04.000.0002	63
EB 569 G	110	EFC 015 K	76	F01.101.0003	57	F02.300.0003	58	F04.000.0003	63
EB 571 E	74	EFC 025 E 001	75	F01.101.0004	57	F02.300.0004	58	F04.000.0004	63
EB 571 G	74	EFC 025 G 001	75	F01.102.0000	57	F02.301.0000	58	F04.001.0000	63
EB 577	78	EHO 010 E	43	F01.102.0001	57	F02.301.0001	58	F04.001.0001	63
EB 578 E	74	EHO 010 G	43	F01.102.0002	57	F02.301.0002	58	F04.001.0002	63
EB 578 G	74	EMC 012 E 100	32	F01.102.0003	57	F02.301.0003	58	F04.001.0003	63
EB 581 E	30, 32	EMC 030 E	34	F01.102.0004	57	F02.301.0004	58	F04.001.0004	63
EB 583 E	75, 106	EMC 030 G	34	F01.200.0000	56	F02.400.0000	58	F04.002.0000	63
EB 583 G	75	EMC 050 E	35	F01.200.0001	56	F02.400.0001	58	F04.002.0001	63
EB 585 E	40, 42	EMC 050 E 007	37	F01.200.0002	56	F02.400.0002	58	F04.002.0002	63
EB 585 G	42	EMC 050 G	35	F01.200.0003	56	F02.400.0003	58	F04.002.0003	63
EB 589 E	110	EMC 050 G 007	37	F01.200.0004	56	F02.400.0004	58	F04.002.0004	63
EB 589 G	110	ESC 012 E	28	F01.201.0000	56	F02.401.0000	58	F04.100.0000	63
EB 590 E	110	ESC 012 E 001	31	F01.201.0001	56	F02.401.0001	58	F04.100.0001	63
EB 590 G	110	ESC 012 E 002	28	F01.201.0002	56	F02.401.0002	58	F04.100.0002	63
EB 591 E	109, 110, 111	ESC 012 E 100	32	F01.201.0003	56	F02.401.0003	58	F04.100.0003	63
EB 591 G	109, 110, 111	ESC 012 E 101	32	F01.201.0004	56	F02.401.0004	58	F04.100.0004	63
EB 593 E	43	ESC 012 G	28	F01.300.0000	56	F03.000.0000	61	F04.101.0000	63
EB 593 G	43	ESC 012 G 001	28	F01.300.0001	56	F03.000.0001	61	F04.101.0001	63
EB 599 E 250	41	ESC 025 E	34	F01.300.0002	56	F03.000.0002	61	F04.101.0002	63
EB 599 E 350	41	ESC 025 E 900	34	F01.300.0003	56	F03.000.0003	61	F04.101.0003	63
EB 599 E 450	41	ESC 025 G	35	F01.300.0004	56	F03.000.0004	61	F04.101.0004	63
EB 616 E	78	ESC 025 G 900	35	F01.301.0000	56	F03.001.0000	61	F04.102.0000	63
EB 616 E 003	78	ESC 030 E 101	33	F01.301.0001	56	F03.001.0001	61	F04.102.0001	63
EB 616 G 003	78	ESC 036 E	28	F01.301.0002	56	F03.001.0002	61	F04.102.0002	63
EB 629 E	78	ESC 036 E 001	28	F01.301.0003	56	F03.001.0003	61	F04.102.0003	63
EB 630 E	72	ESC 036 E 002	28	F01.301.0004	56	F03.001.0004	61	F04.102.0004	63
EB 632 E	108	ESC 036 E 003	28	F01.400.0000	56	F03.002.0000	61	F04.200.0000	62
EB 632 G	108	ESC 040 E 101	33	F01.400.0001	56	F03.002.0001	61	F04.200.0001	62
EB 634 E	32, 33, 40, 41	ESC 050 E	34	F01.400.0002	56	F03.002.0002	61	F04.200.0002	62
EB 641 E	52	ESC 050 E 005	36	F01.400.0003	56	F03.002.0003	61	F04.200.0003	62
EB 642 E	111	ESC 050 E 023	37	F01.400.0004	56	F03.002.0004	61	F04.200.0004	62
EB 643 E	111	ESC 050 E 900	34	F01.401.0000	56	F03.100.0000	61	F04.201.0000	62
EB 700 E	72, 80	ESC 050 E 905	36	F01.401.0001	56	F03.100.0001	61	F04.201.0001	62
EB 701 E	72, 80	ESC 050 E 923	37	F01.401.0002	56	F03.100.0002	61	F04.201.0002	62
EB 702 E	68, 70, 80, 95	ESC 050 G	35	F01.401.0003	56	F03.100.0003	61	F04.201.0003	62
EB 703 E	80	ESC 050 G 005	36	F01.401.0004	56	F03.100.0004	61	F04.201.0004	62
EB 704	112	ESC 050 G 023	37	F02.000.0000	59	F03.10			

Artikel Nr.	Seite/page	Artikel Nr.	Seite/page	Artikel Nr.	Seite/page	Artikel Nr.	Seite/page	Artikel Nr.	Seite/page	Artikel Nr.	Seite/page
F05.101.0002	65	F06.300.0000	66	F07.401.0003	45	F10.101.0000	27	G08.009.0000	88	RB 591	106
F05.101.0003	65	F06.300.0001	66	F07.401.0004	45	F10.102.0000	27	G10.006.0002	88	RB 592	106
F05.101.0004	65	F06.300.0002	66	F08.000.0000	46	F10.200.0000	27	LB 506	22,	RB 601 X	111
F05.102.0000	65	F06.300.0003	66	F08.000.0001	46	F10.201.0000	27	30		RB 602 X	111
F05.102.0001	65	F06.300.0004	66	F08.000.0002	46	F10.300.0000	27	LB 552 E	40	RB 603 X	111
F05.102.0002	65	F06.301.0000	66	F08.000.0003	46	F10.301.0000	27	LB 605	30	RB 643 H 002	24
F05.102.0003	65	F06.301.0001	66	F08.000.0004	46	F10.400.0000	27	LB 606	30	RB 643 H 003	24
F05.102.0004	65	F06.301.0002	66	F08.001.0000	46	F10.401.0000	27	LB 607	22	RB 643 H 006	24
F05.200.0000	64	F06.301.0003	66	F08.001.0001	46	F11.000.0000	92	LB 608	22	RB 648 H 001	84
F05.200.0001	64	F06.301.0004	66	F08.001.0002	46	F11.001.0000	92	LB 609	30	RB 648 H 002	84
F05.200.0002	64	F06.400.0000	66	F08.001.0003	46	F11.002.0000	92	LB 610	30	RB 648 H 003	84
F05.200.0003	64	F06.400.0001	66	F08.001.0004	46	F11.100.0000	92	LSC 030 H 001	22	RB 648 H 004	84
F05.200.0004	64	F06.400.0002	66	F08.002.0000	46	F11.101.0000	92	LSC 030 H 003	22	RB 648 H 005	85
F05.201.0000	64	F06.400.0003	66	F08.002.0001	46	F11.102.0000	92	LSC 070 H 001	30	RB 648 H 006	85
F05.201.0001	64	F06.400.0004	66	F08.002.0002	46	F11.200.0000	92	LSC 070 H 002	30	RB 649 H	69
F05.201.0002	64	F06.401.0000	66	F08.002.0003	46	F11.201.0000	92	LTO 043 H	88	RB 649 H 001	69
F05.201.0003	64	F06.401.0001	66	F08.002.0004	46	F11.300.0000	92	LTO 043 H 001	88	RB 651	107
F05.201.0004	64	F06.401.0002	66	F08.100.0000	48	F11.301.0000	92	NB 001 E	52,	RB 652	107
F05.300.0000	64	F06.401.0003	66	F08.100.0001	48	F11.400.0000	92	54		RB 708	107
F05.300.0001	64	F06.401.0004	66	F08.100.0002	48	F11.401.0000	92	NB 004 E	52,	RB 710 X 001	25
F05.300.0002	64	F07.000.0000	47	F08.100.0003	48	F12.100.0000	93	54		RB 711 X 001	25
F05.300.0003	64	F07.000.0001	47	F08.100.0004	48	F12.101.0000	93	NB 008 H	25	RB 714	107
F05.300.0004	64	F07.000.0002	47	F08.101.0000	48	F12.200.0000	93	NB 008 R 001	25	RB 907 E	25,
F05.301.0000	64	F07.000.0003	47	F08.101.0001	48	F12.201.0000	93	NFC 000 B 402	52	107, 111	
F05.301.0001	64	F07.000.0004	47	F08.101.0002	48	F12.300.0000	93	NFC 000 B 403	52	RCO 015 X 002	49
F05.301.0002	64	F07.001.0000	47	F08.101.0003	48	F12.301.0000	93	NFC 000 E 401	54	RCO 045 X 002	49
F05.301.0003	64	F07.001.0001	47	F08.101.0004	48	F12.400.0000	93	NFC 030 B 302	52	RCO 105 X 002	49
F05.301.0004	64	F07.001.0002	47	F08.102.0000	48	F13.000.0000	90	NFC 030 B 303	52	RFC 020 X	76
F05.400.0000	64	F07.001.0003	47	F08.102.0001	48	F13.000.0001	90	NFC 030 E 301	54	RFC 020 X 002	76
F05.400.0001	64	F07.001.0004	47	F08.102.0002	48	F13.001.0000	90	P01.005.0000	14	RMC 030 X 004	23
F05.400.0002	64	F07.002.0000	47	F08.102.0003	48	F13.001.0001	90	P01.005.0001	14	RMC 050 X	23
F05.400.0003	64	F07.002.0001	47	F08.102.0004	48	F13.002.0000	90	P01.005.0002	14	RSC 050 H 004	24
F05.400.0004	64	F07.002.0002	47	F08.200.0000	44	F13.002.0001	90	P01.005.0003	14	RSC 050 H 006	24
F05.401.0000	64	F07.002.0003	47	F08.200.0001	44	F13.100.0000	90	P01.005.0004	14	RSC 050 H 008	24
F05.401.0001	64	F07.002.0004	47	F08.200.0002	44	F13.100.0001	90	P01.005.0005	14	RSC 080 H 004	24
F05.401.0002	64	F07.100.0000	48	F08.200.0003	44	F13.101.0000	90	P01.005.0006	14	RSC 080 H 006	24
F05.401.0003	64	F07.100.0001	48	F08.200.0004	44	F13.101.0001	90	P01.005.0007	14	RSC 080 H 008	24
F05.401.0004	64	F07.100.0002	48	F08.201.0000	44	F13.102.0000	90	P01.005.0008	15	XB 515 E	112
F06.000.0000	67	F07.100.0003	48	F08.201.0001	44	F13.102.0001	90	P01.005.0009	15	XB 560 E	50
F06.000.0001	67	F07.100.0004	48	F08.201.0002	44	F13.200.0000	90	P01.005.0010	15	XB 561 E	50
F06.000.0002	67	F07.101.0000	48	F08.201.0003	44	F13.200.0001	90	P01.005.0011	15	XB 563	50
F06.000.0003	67	F07.101.0001	48	F08.201.0004	44	F13.201.0000	90	P01.005.0012	15	XB 565	50
F06.000.0004	67	F07.101.0002	48	F08.300.0000	44	F13.201.0001	90	P01.005.0013	15	XB 802 K	112
F06.001.0000	67	F07.101.0003	48	F08.300.0001	44	F13.300.0000	90	P01.006.0000	20	XMC 030 E 001	38
F06.001.0001	67	F07.101.0004	48	F08.300.0002	44	F13.300.0001	90	P01.006.0001	20	XMC 050 E 002	38
F06.001.0002	67	F07.102.0000	48	F08.300.0003	44	F13.301.0000	90	P01.006.0002	20	XSC 025 E 004	38
F06.001.0003	67	F07.102.0001	48	F08.300.0004	44	F13.400.0000	90	P01.006.0003	20	XSC 050 E 004	38
F06.001.0004	67	F07.102.0002	48	F08.301.0000	44	F13.400.0001	90	P01.006.0004	20	Z06 6930	112
F06.002.0000	67	F07.102.0003	48	F08.301.0001	44	F13.401.0000	90	P01.006.0005	20		
F06.002.0001	67	F07.102.0004	48	F08.301.0002	44	F13.401.0001	90	P01.007.0000	16		
F06.002.0002	67	F07.200.0000	45	F08.301.0003	44	F14.000.0000	91	P01.007.0001	16		
F06.002.0003	67	F07.200.0001	45	F08.301.0004	44	F14.000.0001	91	P01.007.0002	16		
F06.002.0004	67	F07.200.0002	45	F08.400.0000	44	F14.001.0000	91	P01.007.0003	16		
F06.100.0000	67	F07.200.0003	45	F08.400.0001	44	F14.001.0001	91	P01.007.0004	16		
F06.100.0001	67	F07.200.0004	45	F08.400.0002	44	F14.002.0000	91	P01.007.0005	17		
F06.100.0002	67	F07.201.0000	45	F08.400.0003	44	F14.002.0001	91	P01.007.0006	17		
F06.100.0003	67	F07.201.0001	45	F08.400.0004	44	F14.100.0000	91	P01.007.0007	17		
F06.100.0004	67	F07.201.0002	45	F08.401.0000	44	F14.100.0001	91	P01.007.0008	17		
F06.101.0000	67	F07.201.0003	45	F08.401.0001	44	F14.101.0000	91	P01.007.0009	17		
F06.101.0001	67	F07.201.0004	45	F08.401.0002	44	F14.101.0001	91	P01.007.0010	17		
F06.101.0002	67	F07.300.0000	45	F08.401.0003	44	F14.102.0000	91	P01.007.0011	16		
F06.101.0003	67	F07.300.0001	45	F08.401.0004	44	F14.102.0001	91	P01.008.0000	18		
F06.101.0004	67	F07.300.0002	45	F09.000.0000	26	F14.200.0000	91	P01.008.0001	18		
F06.102.0000	67	F07.300.0003	45	F09.001.0000	26	F14.200.0001	91	P01.008.0002	18		
F06.102.0001	67	F07.300.0004	45	F09.002.0000	26	F14.300.0000	91	P01.008.0003	18		
F06.102.0002	67	F07.301.0000	45	F09.100.0000	26	F14.300.0001	91	P01.008.0004	18		
F06.102.0003	67	F07.301.0001	45	F09.101.0000	26	F14.301.0000	91	P01.008.0005	18		
F06.102.0004	67	F07.301.0002	45	F09.102.0000	26	F14.301.0001	91	P01.008.0006	18		
F06.200.0000	66	F07.301.0003	45	F09.200.0000	26	F14.400.0000	91	P01.009.0000	19		
F06.200.0001	66	F07.301.0004	45	F09.201.0000	26	F14.400.0001	91	P01.009.0001	19		
F06.200.0002	66	F07.400.0000	45	F09.300.0000	26	F14.401.0000	91	RB 568	107		
F06.200.0003	66	F07.400.0001	45	F09.301.0000	26	F14.401.0001	91	RB 569	107		
F06.200.0004	66	F07.400.0002	45	F09.400.0000	26	G03.009.0002	88	RB 582	107		
F06.201.0000	66	F07.400.0003	45	F09.401.0000	26	G06.002.0000	82	RB 584	107		
F06.201.0001	66	F07.400.0004	45	F10.000.0000	27	G06.002.0002	82	RB 585	107		
F06.201.0002	66	F07.401.0000	45	F10.001.0000	27	G06.013.0000	82	RB 586	107		
F06.201.0003	66	F07.401.0001	45	F10.002.0000	27	G06.013.0001	82	RB 588	107		
F06.201.0004	66	F07.401.0002	45	F10.100.0000	27	G06.013.0002	82	RB 589	107		



designed by *Colan*

Der Frilich EdelstahlHahn ist ein von Frilich aus der Praxis der Gastronomie heraus konzipierter Auslaufhahn, der höchste Ansprüche an Qualität und Handhabung erfüllt. Durch die großzügige Auslauföffnung bietet er bequeme und zuverlässige Entnahme des Saftes bzw. der Milch. Er ist aus solidem Edelstahl gefertigt, spülmaschinengeeignet und bei richtiger Pflege hat der Hahn eine extrem lange Lebensdauer.

The Frilich stainless steel faucet is conceived from Frilich on basis of long years experience in the gastronomy, which fullfills highest standards at quality and handling. The large outlet guarantees a comfortable and reliable serving of the juice /milk. It is produced of solid stainless steel, dishwasher-proof and if it is maintained in the right manner the faucet has an extreme long service life.

Kein Werkzeug für die Reinigung verwenden!

Do not use tools for cleaning!



Verwendung von Konzentrat (bsp. Essigsäure) zum Einweichen bzw. Vorreinigen ist nicht geeignet.

Do not use concentrate (e. g. acetic acid) for pre-cleaning.



• Verwendung von Konzentrat (bsp. Essigsäure) zum Einweichen bzw. Vorreinigen ist nicht geeignet. Do not use concentrate (e. g. acetic acid) for pre-cleaning.

• Nur mit handelsüblichen bzw. herkömmlichen Reinigungsmitteln/ Reinigungsgeräten reinigen/säubern. Safe for cleaning with commercially available/conventional cleaning agents and devices.

Zeichenerklärung



Für die Reinigung in der Spülmaschine geeignet. Gilt bei Produkten Modell ‚Gold‘ jedoch nur für Behälter zur Präsentation und Aufbewahrung der Getränke bzw. Speisen.



Behälter zur Präsentation und Aufbewahrung der Getränke bzw. Speisen sind für die Reinigung in der Spülmaschine geeignet.



Das Produkt muss mit geeigneten Pflegemitteln achtsam per Hand gereinigt werden und ist für die Reinigung in der Spülmaschine nicht geeignet.



Getränke werden doppelt gekühlt. Besonders effektive Kühlung durch Kombination von Edelstahl-Crasheisröhre mit kompaktem Kühlakku



Speisen werden mittels Kühlkissen gekühlt. Die Kühlkissen verbleiben mindestens 6 Stunden vor Gebrauch im Gefrierfach. Wir empfehlen, zum Austausch immer das mitgelieferte Kühlkissen Austausch-Set gefroren bereitzuhalten.



Kompakte Kühlakkus sorgen für anhaltende Kühlung von Speisen und Getränken. Die Kühlakkus verbleiben mindestens 6 Stunden vor Gebrauch im Gefrierfach.



Die Kühlung der Getränke bzw. Speisen erfolgt über elektrischen Anschluß (100 V–230 V/12 V, 65 W). Sicherheitsbedingungen für elektrische Geräte sind zu beachten.



Produkt wird mit elektrischem Anschluss betrieben (100 V–230 V/12 V, 13 W). Sicherheitsbedingungen für elektrische Geräte sind zu beachten.



Gefertigt aus hochwertigem Edelstahl 18/10. Die Ausführung ‚Edelstahl‘ ist hochglanz-poliiert. Das Modell ‚Gold‘ ist 24-Karat hartvergoldet. Wir empfehlen die Reinigung mit einem weichen, angefeuchteten Lappen. Keine aggressiven Pflegemittel verwenden.



Gefertigt aus hochwertigem Edelstahl. Anschließend ist die Oberfläche matt nachbehandelt.



Produkt ist aus Kunststoff in gefrosteter Optik (satiniertes Oberfläche) gefertigt. Das durchscheinende Material ist reinigungsfreundlich und vermittelt dem Buffet Leichtigkeit und Frische.



Getränke/Speisen werden besondes hygienisch im Behälter aus hochwertigem Edelstahl angeboten. Wir empfehlen die Reinigung des Behälters in der Spülmaschine.



Die besonders robusten Kunststoffbehälter für Speisen und Getränke sind in gefrosteter Optik (Opal) erhältlich. Dadurch erscheinen die Behälter besonders andauernd hochwertig und Saft- bzw. Speiserückstände sind weniger erkennbar, d. h. Lebensmittel werden appetitlich präsentiert.



Behälter bzw. Platten sind aus schlagfestem, spülmaschinengeeignetem sowie für die Verwendung in der Mikrowelle geeignetem Porzellan gefertigt und für den Gastronomieinsatz empfohlen.



Bei Bedarf sind Deckel bzw. Abdeckung für das Buffetprodukt optional erhältlich. Weitere Informationen entnehmen Sie bitte dem Frilich Produktkatalog.



Deckel sind mit einem praktischen Deckelhaltersystem ausgestattet. Im Einsatz wird der Deckel einfach auf den Behälterring aufgesteckt, so sind sie stets sofort zur Hand. Milchkannen sind nicht damit ausgestattet.



Im Lieferumfang sind zusätzlich zu den Standard-Deckeln die ‚Gute-Nacht-Deckel‘ eingeschlossen. Diese werden nach dem Einsatz auf dem Buffet auf den Behältern aufgesetzt und sorgen bei Lagerung für hygienischen Schutz.



Handgefertigtes Stahl-Gestell. Besonders schlagfest durch solide schwarze Pulverbeschichtung.



Holzblock aus naturbellassener massiver Buche. Geölte Oberfläche ist feuchtigkeitsabweisend und sorgt für langanhaltende Qualität. Mit Pflegemitteln für Holz reinigen bzw. nur leicht feucht abwischen. Nicht für die Reinigung in der Spülmaschine geeignet!



Holzblock aus massiver Buche, dunkel gebeizt. Butcher Blöcke sind auf der Präsentationsfläche unbehandelt. Geölte Oberfläche ist feuchtigkeitsabweisend und sorgt für lang anhaltende Qualität. Mit Pflegemitteln für Holz reinigen bzw. nur leicht feucht abwischen. Nicht für die Reinigung in der Spülmaschine geeignet!



Mehrfach verleimtes Multiplexholz, Buche natur, gibt dem Standfuß besondere Stabilität. Mit Pflegemitteln für Holz reinigen bzw. nur leicht feucht abwischen. Nicht für die Reinigung in der Spülmaschine geeignet!



Glasbehälter sind nicht zur Reinigung in der Spülmaschine geeignet. **ACHTUNG:** Materialbedingt können an der Glasbohrung Risse entstehen. Nach jedem Gebrauch die Unversehrtheit der Bohrung überprüfen. Glasbehälter nicht einsetzen, wenn Risse im Glas festgestellt werden. **VERLETZUNGSGEFAHR!**



Produkte sind aus hochwertigem, widerstandsfähigem Holz des Gummibaumes gefertigt. Die Oberfläche ist optisch besonders holztypisch strukturiert. Durch aufwendiges Fertigungsverfahren ist die Formstabilität sowie die Langlebigkeit besondes optimiert. Mit Pflegemitteln für Holz reinigen bzw. nur leicht feucht abwischen. Nicht für die Reinigung in der Spülmaschine geeignet!



Hi-Macs ist ein hochwertiges Kunststoff-Stein-Gemisch mit höchster Widerstandsfähigkeit, Funktionalität, überzeugender Optik und garantiert eine leichte Pflege. Das Material eignet sich hervorragend für den Einsatz in der Gastronomie.



Produkt aus Metallstäben gefertigt und verchromt. Nicht zur Reinigung in der Spülmaschine geeignet.



Produkt aus echtem Speckstein, handgefertigt und zur Reinigung in der Spülmaschine geeignet.



Produkt aus spülmaschinengeeignetem Kunststoff zu einem Weidekorb gewebt.

Legend

Suitable for dishwasher use. In reference to products in model ‘Gold’ only containers for presentation and storage of beverages of food are suitable for dishwasher use.

Containers for presentation and storage of beverages or food are suitable for dishwasher use.

The product must be cleaned carefully with suitable detergents by hand, it is not dishwasher-proof.

Beverages remain fresh and cool for longer periods, with double effective cooling through the combination of stainless steel crushed ice tubes and compact cooling pack.

Food remains fresh through the use of cooling cushions. The second set of delivered cooling cushions have to be frozen at least 6 hours before use.We suggest to have in store a frozen replacement set of cooling cushions.

Compact cooling packs provide for long-lasting cooling of food and beverages. The cooling packs have to be frozen at least 6 hours before use.

Beverages and food remain cool and fresh by use of electric power (100 V–230 V/12 V, 65 W). Safety instructions for electrical equipment have to be followed.

Electric operated product (100 V–230 V/12 V, 13 W). Safety instructions for electrical equipment have to be followed.

Made of high-quality stainless steel 18/10. The model ‘Stainless Steel’ is mirror-finished. The model ‘Gold’ is 24-carat gold-plated. We suggest to use a soft damp cloth and no aggressive cleaning agents.

Made of high-quality stainless steel with satin-finished surface.

The product is made of plastic material in frosted look (satined surface). It is easy to clean and communicates lightness and freshness on the buffet.

Beverages/food are offered in a special hygienic manner in a container made of high-grade stainless steel. We recommend to clean the container in the dishwasher.

The particular solid containers for food and beverages are available in frosted look (translucent). The content has an extra long-lasting high-value appearance, juice- or food residues are hidden, which guarantees an appetizing presentation of food.

Container respectively plates are made of impact-resistant, dishwasher-proof chinaware, which is suitable for the microwave. It is recommended for use in the gastronomy.

Lids or covering options for this buffet product are available optionally. For further information please see the Frilich product catalogue.

Lids are quipped with a practical lid holder system. During use the lid is simply attached on the edge of the container. Thus the lid is always ready to hand. Milk can lids are not equipped with a lid holder.

Included in delivery to the standard lids, this product comes with ‘Good Night Lids’. These lids are used at the end of buffet service to ensure hygienic protection during storage.

Hand-made steel base. Especially impact-resistant due to the black powder coating.

Stand made of solid beech, natural finish. Oiled surface is moisture repellent and provides long-lasting quality. To clean with care products for wood or rather to clean slightly with a damp cloth. Not suitable for cleaning in the dishwasher!

Stand made of solid beech, dark pickled. Oiled surface is moisture repellent and provides long-lasting quality. To clean with care products for wood only or rather to clean slightly with a damp cloth. Not suitable for cleaning in the dishwasher!

Repeatedly glued Multiplex wood, natural beech, gives the base a particular stability. To clean with care products for wood only or rather to clean slightly with a damp cloth. Not suitable for cleaning in the dishwasher!

Glass containers are not suitable for cleaning in the dishwasher. **ATTENTION:** Due to the material, cracks can occur at the glass bore. Check the integrity of the bore after each use. Do not use the glass container if cracks are found in the glass. **RISK OF INJURY!**

Products are made of high-quality, robust wood of the rubber tree. The optic of the surface is characterized by the wooden structure. A complex manufacturing process optimizes form stability and longevity. To clean with care products for wood only or rather to clean slightly with a damp cloth. Not suitable for cleaning in the dishwasher!

Hi-Macs is a high-grade plastic-stone-composite of utmost durability, functionality, convincing visual appearance and provides easy care. The material is excellent for use in the gastronomy.

Product made of metal rods and chromium plated. Not suitable for dishwasher use.

Product made of natural soapstone, handcrafted and suitable for dishwasher use.

Wicker basket made of dishwasher plastic material, suitable for dishwasher use.

Légende



Compatible lave-vaisselle. Pour les produits finition dorée, compatibilité uniquement pour les récipients de présentation et de conservation des boissons et/ou des mets.



Récipients de présentation et de conversation des boissons et/ou de la nourriture compatibles lave-vaisselle.



Le produit doit être nettoyé attentivement à la main en utilisant des produits d’entretien appropriés. Il ne sont pas compatibles avec le lave-vaisselle.



Les boissons sont doublement rafraîchies. Refroidissement particulièrement efficace grâce à la combinaison d’un tube à glace broyée en inox avec un élément de réfrigération compact.



La nourriture est rafraîchie par des coussins de réfrigération. Les coussins de réfrigération doivent rester 6 h avant usage au congélateur. Nous recommandons de tenir le set de coussins de remplacement inclu à disposition au congélateur.



Les éléments de réfrigération veillent à ce que les boissons et la nourriture soient tenus au froid. Les éléments sont à mettre au congélateur au moins 6 heures avant utilisation.



Le refroidissement des boissons et de la nourriture s’effectue grâce à une connexion électrique (100V–230V/12V, 65W). Les dispositions de sécurité pour les appareils électriques sont à suivre.



Le produit est muni d’un raccordement électrique (100 V–230 V/12V, 13W). Les dispositions de sécurité pour des appareils électriques sont à suivre.



Fabriqu é en inox de haute qualité 18/10. La surface de la finition “Inox” est polie brillant. La finition dorée est dorée à l’or 24 carats. Nous recommandons le nettoyage doux avec un chiffon humide. Ne pas utiliser de détergents agressifs.



Fabriqu é en inox de haute qualité. Surface dépolie.



Le produit fini est d’apparence “givr é” (matériel surface satinée). Le matériel translucide facilite le nettoyage, Il inspire légèreté et fraîcheur au buffet.



Des boissons sont offertes de manière particulièrement hygiénique grâce aux récipients en inox de haute qualité. Un nettoyage du récipient au lave-vaisselle est recommandé.



Les récipients, pour la nourriture et les boissons, particulièrement solides sont disponibles en apparence “givr é” (matériel translucide). Les récipients ont l’air de grande valeur, des résidus du jus et/ou de nourriture sont dissimulés ce qui garantie une présentation appétissante des victuailles.



Les récipients et/ou plaques/couppelles sont fabriqués en porcelaine résistante aux chocs, compatibles lave-vaisselle et micro-onde, recommandés pour usage en gastronomie.



Des couvercles de protection sont disponibles en option. Vous trouverez des informations plus détaillées dans le catalogue de produits Frilich.



Les couvercles sont équipés d’un support pratique. Le couvercle est décroché tout simplement au bord du récipient, ainsi ils sont disponibles tout de suite sous la main. Le couvercle de la laitière n’est pas équipé de ce support.



Dans la livraison des couvercles standards sont inclus les couvercles “Bonnes nuit”, Ces couvercles sont utilisés à la fin du service du buffet afin d’assurer une protection totalement hygiénique pendant le stockage.



Base en acier fait main. Particulièrement résistant aux chocs grâce au revêtement par poudre noire.



Support bois naturel massif. La surface lubrifiée repousse l’humidité et assure une qualité prolongée. Nettoyer uniquement avec des produits d’entretien pour le bois, simplement essuyer avec un chiffon humide. Ne passe pas au lave-vaisselle!



Support bois naturel massif, bruni foncé. La surface lubrifiée repousse l’humidité et assure une qualité prolongée. Nettoyer avec des produits d’entretien pour le bois, essuyer doucement avec un chiffon humide. Ne passe pas au lave-vaisselle!



Du bois Multiplex collé, hêtre naturel, donne à la base une stabilité extraordinaire. A nettoyer avec des produits d’entretien pour le bois, essuyer doucement avec un chiffon humide. Le bois ne passe pas au lave-vaisselle.



Les récipients en verre ne sont pas compatibles avec le lave-vaisselle. **ATTENTION:** en raison de la matériel, des fissures se peuvent former sur le trou du verre. Vérifiez l’intégrité de l’alésage après chaque utilisation. Ne pas utilisez le récipient en verre si observez des fissures dans le verre. **RISQUE DE BLESSURE!**



Les produits sont fabriqués en bois de caoutchouc de haute qualité et résistant. L’optique de la surface est particulièrement caractérisé par la structure de bois typique. Une procédure de production complexe optimise la stabilité de forme ainsi que la longévité. Nettoyer avec des produits d’entretien pour le bois, essuyer doucement avec un chiffon humide. Pas compatible avec le lave-vaisselle!



Hi-Macs est un matériel plastique de haute qualité qui est caractérisé d’une extrême résistance, fonctionnel, visuellement convaincant et qui garantit un soin facile. Ce matériel est excellent pour usage en gastronomie.



Produits fabriqués avec du métal et du chrome. Lave-vaisselle non conseillé.



Produit fabriqué à la main en pierre naturelle. Utilisation du lave-vaisselle conseillé.



Tressage panier fait de matière plastique. Utilisation du lave-vaisselle conseillée.

Leyenda

Apto para la limpieza en el lavavajillas. Es válido para el modelo “Oro” pero solo para los depósitos de presentación y conservación de bebidas y alimentos.

Los depósitos para la presentación y conservación de bebidas y alimentos son aptos para su limpieza en el lavavajillas.

El producto tiene que ser limpiado a mano con productos adecuados y no es apto para el lavavajillas.

Las bebidas se mantienen más tiempo frías, por el efecto de doble enfriamiento de la combinación del recipiente de hielo de acero inoxidable con la bolsa enfriadora compacta.

Los alimentos se enfrían mediante bolsas enfriadoras. Las bolsas enfriadoras tienen que estar al menos 6 horas en el congelador antes de su uso. Nosotros recomendamos tener siempre a mano el juego de recambio de la bolsa enfriadora, que va incluida.

Las bolsas enfriadoras compactas ofrecen un enfriamiento duradero de los alimentos y bebidas. Las bolsas enfriadoras tienen que estar al menos 6 h en el congelador antes de su uso.

El enfriamiento de las bebidas y alimentos se hace por conexión eléctrica (100V–230V/12V, 65W). Hay que tener en cuenta las instrucciones de seguridad para aparatos eléctricos.

El producto funciona mediante conexión eléctrica (100V–230V/12V, 13W). Hay que tener en cuenta las instrucciones de seguridad para aparatos eléctricos.

Fabricado en acero inoxidable 18/10 de alta calidad. El modelo “Acero” es pulido. El modelo “Oro” lleva un baño de oro de 24 quilates. Nosotros recomendamos usar un paño suave y húmedo. No utilizar detergentes abrasivos.

Fabricado de acero inoxidable de alta calidad. El acabado de la superficie es mate.

El producto es de material sintético en versión opalina. Es fácil de limpiar y transmite ligereza y frescura en el buffet.

Las bebidas se ofrecen de una manera especialmente higiénicas en los depósitos de acero inoxidable de alta calidad. Nosotros recomendamos la limpieza del depósito en el lavavajillas.

Incluidas en los envíos de las tapas están las tapas de buenas noches. Estas tapas son utilizadas una vez haya terminado el servicio de buffet y así se asegura una protección higiénica de las bebidas.

Los recipientes y bandejas son de porcelana resistente a la rotura y apta para el lavavajillas así como para el microondas y recomendados para la utilización en la gastronomía.

El enfriamiento de las bebidas y alimentos se hace por conexión eléctrica (100V–230V/12V, 65W). Hay que tener en cuenta las instrucciones de seguridad para aparatos eléctricos.

Las tapas están equipadas con un práctico sistema de sujeción. En el uso se coloca la tapa en el borde del recipiente, así siempre están a mano.

Incluidas en los envíos de las tapas están las tapas de buenas noches. Estas tapas son utilizadas una vez haya terminado el servicio de buffet y así se asegura una protección higiénica de las bebidas.

Soporte de acero hecho a mano. Especialmente resistente a los golpes por un recubrimiento negro de polvo.

Soporte de madera de haya maciza natural. La superficie aceitada repele la humedad y garantiza una calidad duradera. Limpiar con detergentes para limpiar madera o simplemente con un paño húmedo. No apto para el uso en el lavavajillas!

Soporte de madera de haya maciza, con barniz oscuro. La superficie aceitada repele la humedad y garantiza una calidad duradera. Limpiar con detergentes para limpiar madera o simplemente con un paño húmedo. No apto para el uso en el lavavajillas!

Madera Mulíplex pegada repetidas veces, haya natural, da a la base una especial sujeción. Limpiar con productos para madera o con un paño húmedo. No apto para la limpieza en el lavavajillas.

Los recipientes de vidrio no son aptos para la limpieza en el lavavajillas. **ATENCIÓN:** debido al material, pueden producirse grietas en el orificio de vidrio. Compruebe la integridad del orificio después de cada uso. No use el recipiente de vidrio si se encuentran grietas en el vidrio. **RIESGO DE LESIONES!**

Productos fabricados de madera de alta calidad y robusta del árbol del caucho. La visión de la superficie es característica de la estructura de madera. Un proceso complejo de fabricación optimiza la estabilidad de la forma y su longevidad. Limpiar con productos para madera o con un paño húmedo. No apto para la limpieza en el lavavajillas.

Hi-Macs es un material plástico de alta calidad muy robusto y funcional, de apariencia visual convincente, que garantiza una limpieza fácil. Este material es apto excelente para el uso en la gastronomía.

Producto fabricado y cromado de barras metálicas. No es apto para el lavavajillas.

Producto de auténtica piedra esteatita, hecho a mano y apto para el lavavajillas.

Producto de plástico tejido en una cesta de mimbre y apto para el lavavajillas.

Allgemeine Verkaufs- und Lieferbedingungen

Die folgenden Allgemeinen Verkaufs- und Lieferbedingungen gelten nur für den kaufmännischen und öffentlichen Bereich gemäß § 24 Ziff. 1 und 2 AGB Gesetz und finden, soweit nichts anderes vereinbart, auf für alle künftigen Geschäfte mit uns Anwendung.

I. Angebot und Vertragsabschluss

Unsere Angebote sind freibleibend. Der Vertrag kommt erst durch unsere Auftragsbestätigung oder durch Ausführung des Auftrags zustande. Abweichungen von diesen Verkaufsbedingungen bedürfen unserer ausdrücklichen, schriftlichen Anerkennung.

II. Preise, Zahlungsbedingungen

Die Preise sind netto zuzüglich des jeweils gültigen Mehrwertsteuersatzes. Unsere Rechnungen sind zahlbar innerhalb von 30 Tagen nach Rechnungsdatum ohne jeden Abzug. Bei Bezahlung innerhalb von 10 Tagen nach Rechnungsdatum gewähren wir, falls es nicht anders vereinbart ist, 2 % Skonto, sofern vorhergehende Rechnungen ausgeglichen sind. Wir sind bei Überschreitung dieser Zahlungsfrist unter Vorbehalt der Geltendmachung eines weiteren Verzugschadens ohne Mahnung berechtigt, Zinsen in Höhe von 2 % über dem Diskontsatz der Deutschen Bundesbank zu verlangen. Sollten wir in der Zeit zwischen Vertragsabschluss und Lieferung unsere Preise allgemein ermäßigen oder erhöhen, so wird der am Tage des Versands gültige neue Preis berechnet. Falls sich der Preis erhöht, ist der Besteller berechtigt, innerhalb von 14 Tagen nach Mitteilung der Preiserhöhung vom Vertrag zurückzutreten. Wir behalten uns vor, Zahlungen zur Begleichung der ältesten Rechnungsposten zuzüglich der darauf aufgelaufenen Verzugszinsen und Kosten zu verwenden, und zwar in der Reihenfolge: Kosten, Zinsen, Hauptforderung.

Die Aufrechnung mit anderen als unbestritten oder rechtskräftig festgestellten Gegenansprüchen sowie die Ausübung von Leistungsverweigerungs- und Zurückbehaltungsrechten gegen Kaufpreisforderungen bedürfen unserer Zustimmung. Bei Zweifeln an der Zahlungsfähigkeit eines Bestellers, insbesondere bei Zahlungsrückstand, sind wir vorbehaltlich weitergehender Ansprüche berechtigt, für weitere Lieferungen Vorauszahlungen und Sicherheiten zu verlangen sowie eingeräumte Zahlungsziele zu widerrufen. Bei Erstaufträgen behalten wir uns vor, nur gegen Vorauskasse oder per Nachnahme Waren auszuliefern.

III. Lieferung, Vertragshindernisse

Lieferfristen sind unverbindlich, soweit nicht im Einzelfall ausdrücklich Gegenteiliges vereinbart ist. Teillieferungen sind zulässig. Bei Vereinbarung eines festen Liefertermins hat der Besteller im Falle unseres Verzugs eine angemessene Nachfrist von mindestens 4 Wochen zu setzen. Erfolgt die Lieferung auch bis zum Ablauf der Nachfrist nicht, hat der Besteller das Recht zum Rücktritt vom Vertrag. Nimmt der Besteller die Ware nicht ab, sind wir berechtigt, nach Setzen einer Nachfrist von 10 Tagen vom Vertrag zurückzutreten oder Schadensersatz wegen Nichterfüllung zu verlangen. Im letzteren Fall sind wir berechtigt, entweder ohne Nachweis eines Schadens 25 % des Kaufpreises oder Ersatz des tatsächlich entstandenen Schadens zu verlangen. Die Rückgabe von Sonderanfertigungen jeglicher Art sowie Artikeln außerhalb unseres Standard-Programmes ist nicht möglich. Darunter fallen auch jene Artikel, die speziell im Kundenauftrag bei dem Vorlieferanten bestellt werden müssen. Alle Bestellungen werden unter dem Vorbehalt der allgemeinen Herstellungsmöglichkeit angenommen. Höhere Gewalt jeder Art berechtigt uns, von dem Vertrag ganz oder teilweise zurückzutreten, ohne dass der Besteller ein Recht auf Schadensersatz hat. Der Besteller ist bei Eintreten derartiger Ereignisse berechtigt, nach Ablauf einer angemessenen Nachfrist vom Vertrag zurückzutreten. Weitergehende Rechte kann der Besteller nicht geltend machen. Zu Teillieferungen und Teilleistungen sind wir jederzeit berechtigt. Der Versand erfolgt im Inland bis EUR 150,- immer ab Werk. Bei Rechnungen über EUR 150,- Warenwert liefern wir im Inland frei Haus. Außerhalb Deutschlands liefern wir immer ab Werk. Der Versand erfolgt auf Rechnung und Gefahr des Käufers. Für Beschädigungen und Verluste während des Transports haften wir nicht. Sofern nicht anders vereinbart, wählen wir Versand und Verpackung nach bestem Ermessen. Eine Versicherungspflicht übernehmen wir nicht. Auf schriftliches Verlangen des Käufers wird die Ware jedoch gegen Transportschäden und andere Schäden versichert.

IV. Eigentumsvorbehalt

Alle von uns gelieferten Waren bleiben unser Eigentum, solange wir aus der Geschäftsverbindung mit dem Käufer noch Zahlungsansprüche gegen ihn haben. Mit der Annahme unserer Ware tritt der Käufer bis zur völligen Bezahlung unserer Forderungen die ihm aus der Weiterveräußerung der in unserem Eigentum stehenden Waren gegen seine Abnehmer erwachsenden Forderungen mit allen Nebenrechten an uns ab. Zugriffe auf die in unserem Eigentum oder Miteigentum stehenden Waren und uns abgetretene Forderungen sind uns vom Käufer unverzüglich anzuzeigen.

V. Mängel- und Schadenshaftung

Mängelrügen werden nur berücksichtigt, wenn sie unverzüglich, schriftlich, spätestens jedoch innerhalb von 14 Tagen nach Erhalt der Ware unter Einsendung von Belegen, Mustern sowie der Angabe von Rechnungsnummer und Rechnungsdatum erhoben werden. Transportschäden müssen umgehend beim Wareneingang, spätestens jedoch innerhalb von 2 Arbeitstagen schriftlich reklamiert werden. Die Rücksendung beanstandeter Ware darf nur mit unserer Zustimmung erfolgen.

VI. Garantie

Die Garantie erstreckt sich auf den Ersatz oder die Instandsetzung fehlerhafter Teile. Nicht unter die Garantie fallen Schäden, die zurückzuführen sind auf: unsachgemäße Bedienung des Gerätes, insbesondere falsche oder unzureichende Reinigung, natürliche Abnutzung, normalen Verschleiß. Unsere Garantie gilt nur innerhalb der Bundesrepublik Deutschland gegenüber Kunden, die das Gerät als erster oder von einem unserer Wiederverkäufer von uns beziehen. Die Garantie beginnt mit dem Lieferdatum, sie beträgt 12 Monate. Werden Bedienungs- und Reinigungsanweisungen nicht befolgt, entfällt jede Gewährleistung. Beanstandungen jeglicher Art müssen uns innerhalb von 8 Tagen nach Erhalt der Ware bzw. unmittelbar nach Auftreten des Schadens schriftlich angezeigt werden. Die unter die Gewährleistung fallenden Teile werden nicht berechnet, während Transportkosten, Arbeitszeit und Reisezeit zu unseren Standardsätzen zu bezahlen sind. Ein über die Garantiebedingungen hinausgehender Anspruch, insbesondere auf Ersatz von Folgeschäden, besteht nicht.

VII. Erfüllungsort und Gerichtsstand, Wirksamkeitsklausel, Datenverwendung

Erfüllungsort für die Leistung des Bestellers ist Gießen. Ist der Besteller Vollkaufmann, so ist der Gerichtsstand Gießen oder nach unserer Wahl der allgemeine Gerichtsstand des Bestellers. Sind oder werden einzelne Bestimmungen dieser Bedingungen oder des Liefergeschäftes unwirksam, so wird dadurch die Wirksamkeit der übrigen Bestimmungen nicht berührt. Eine wirksame Regelung gilt als durch eine solche Regelung ersetzt, die dem wirtschaftlichen Zweck der unwirksamen Regelung am nächsten kommt und wirksam ist. Wir sind berechtigt, die bezüglich der Geschäftsbeziehung oder im Zusammenhang mit dieser erhaltenen Daten über den Besteller, gleich ob diese vom Besteller selbst oder von Dritten stammen, im Sinne des Bundesdatenschutzgesetzes zu verarbeiten.

Frilich GmbH
Buseck, September 2019

Preise:

Dieser Katalog mit seinen ausgewiesenen Preisen hat Gültigkeit ab 1. September 2019. Alle vorherigen Kataloge und Preise verlieren ab diesem Zeitpunkt ihre Gültigkeit. Die Katalogpreise gelten solange der Warenvorrat reicht, längstens jedoch bis Erscheinen des Nachfolge-Kataloges bzw. einer Nachfolge-Preisliste.

Zum Katalog:

Nachdruck, auch auszugsweise, bedarf unserer schriftlichen Genehmigung. Die Fotos bzw. Zeichnungen stammen aus Eigenproduktion. Alle Rechte daraus bleiben vorbehalten. Alle Größenangaben sind Circa-Angaben, Änderungen behalten wir uns vor. Für Irrtümer und Druckfehler übernehmen wir keine Gewähr.

Standard Terms of Sales and Delivery

The following Standard Terms of Sales and Delivery apply only to commercial and public sectors according to article 24, sections 1 and 2 of the laws governing Standard Terms and Conditions of Trade (AGB Gesetz) in Germany and, if no other provisions are made, shall apply to all future business with us.

I. Quotations and Conclusion of Contract

1. Our quotations are non-binding and subject to change without notice. The contract shall not become effective until we acknowledge and confirm the order, in writing, or the order is executed. We reserve the right to impose a 5 % export charge (max. EUR 80,-) on export orders for goods within Europe and a 5 % export charge (max. EUR 150,-) on goods exported outside Europe. This covers special packing, handling of export documents, bank charges etc.
2. Any deviation from these conditions of sales must be approved by us in writing.

II. Prices, Terms of Payment

1. All prices are net.
2. Payment has to be made according to the confirmation. Should the buyer fail to meet our payment terms within the agreed period, we are authorized, without issuing a specific reminder, to charge interest of 2 % above the discount rate of the German Bundesbank and we reserve the right to claim any further damages resulting from arrears.
3. Should it arise that, in the period between confirmation of an order and delivery, we are obliged to lower or raise prices, the price to be paid is the new price, valid on the day the goods are dispatched. Should the price be raised, the buyer has the right to withdraw from contract within 14 days after notification of any price rise.
4. We reserve the right to make use of payments made, including any default interest and costs accrued on them, to settle longest outstanding accounts in the following order: costs, interest, principal debt.
5. Counterbalancing price claims with opposing claims that have proven indisputable and legally valid as well as the exercising of rights to refuse payment and withhold goods require our consent.
6. If the customer's ability to pay is in doubt, especially if payments are in arrears, we may, failing more extensive claims, demand payment in advance and security for further orders; we may also revoke granted credit terms.
7. On orders placed for the first time, we reserve the right to deliver the goods against prepayment.

III. Delivery, Force Majeure

1. Delivery deadlines are non-binding, provided nothing has been explicitly agreed to the contrary in a particular case. The seller is authorized to deliver by instalments. We assume no responsibility for events or circumstances occurring due to force beyond our control, not even when binding time limits have been agreed on. When a fixed delivery deadline has been set which the seller fails to meet, buyer is to extend the deadline by an appropriate period of at least 6 weeks. Should seller still fail to deliver the goods within the extension period, the buyer has the right to withdraw from the contract.
2. Should buyer refuse to take delivery, seller is authorized to withdraw from the contract after extending the delivery deadline by 10 days or to claim damages on the grounds of non-fulfillment. In the latter case, the seller is authorized with or without presentation of proof or damage to claim 25 % of purchasing price or compensation for the damage actually sustained.
3. Articles on special offer cannot be exchanged. The seller refuses to accept both the return of any non-standard-line goods specially manufactured and any articles not included in our standard stock programme. This also includes articles which require special ordering from outside suppliers on a client's behalf.
4. Dispatched is always ex works at the buyer's risk and on account. If there is a danger that the buyer may have reason to delay the dispatch of goods, he must warn seller of this danger when dispatch terms are agreed on. Seller assumes no responsibility for damage to and loss of goods in transit. Frilich reserve the right to choose how goods are to be packed and dispatched unless alternative arrangements have been made. Seller assumes no responsibility for insurance coverage. Should, however, buyer express in writing the wish to have goods insured against damage caused in transit or due to other factors, we will gladly comply.

IV. Ownership Proviso

1. We reserve the ownership of goods delivered until the amounts charged have been paid in full. Invoices are regarded as paid when we are in receipt of the amounts due.
2. Should buyer fall into arrears of fail to fulfil obligations arising from the ownership proviso agreed on, seller is authorized, even without making use of right to withdraw from contract and without extending deadline, to demand that, at the expense of the buyer, the goods in his possession be returned to him and that he collect them from the buyer. Further to this, all outstanding balances must be settled by the buyer immediately. Seller's reacquisition of the goods delivered does not classify as a withdrawal from contract. After giving buyer fair warning and setting an adequate deadline, we are authorized to make as good a direct sales as possible of the goods previously dispatched, adding a supplementary charge to the purchasing price. Buyer must bear all costs of our reacquiring and reselling the goods. Realization costs are 20 % of proceeds from sale of the goods, inclusive of turnover tax, and do not require verification.

V. Liability for Defects and Damages

1. Complaints will be taken into account only if they are made immediately in writing or, at the latest, within 8 days of receipt of the goods, and are sent to seller along with receipts and samples plus number and date of invoice. Where damage has been caused in transit, complaints must be lodged in writing immediately on receipt of goods by buyer or, at the latest, within 2 workdays.
2. Goods which are the object of complaint may not be returned to us unless our consent has been given.

VI. Warranty

1. The warranty covers the replacement or repair of defective parts. Excluded from this warranty are damages which result from:
a) Improper handling of the device, especially improper or insufficient cleaning.
b) Natural, normal wear and tear
2. Our warranty only applies within the Federal Republic of Germany, for customers who have purchased the device directly from us or from one of our dealers. The warranty begins on the date of delivery and extends over 12 months.
3. Disregard to operating and cleaning instructions results in the cancellation of this warranty.
4. Complaints of any kind must be made to us, in writing, within 14 days after receipt of the goods or immediately upon occurrence of the damage.
5. Parts included in the warranty will not be invoiced, whereas shipping costs, labour and travel time are to be paid at our standard rates.
6. No claims beyond those stated in this warranty may be made, especially regarding compensation for subsequent damage.

VII. Place of Fulfilment and Seat of Jurisdiction

1. The place of fulfilment from which services to seller are operated is Giessen, Germany. If buyer is an accredited businessman, the responsible legal authority is Giessen or, at our discretion, the buyer's local court.

Frilich GmbH
Buseck, September 2019

Prices

This catalogue and the prices given in it are effective as from 01-09-2019. All previous catalogues and former prices are invalid from this date on. The catalogue prices remain valid as long as present stocks last or, until a new catalogue, with a new price list, is published.

Use of Data

Copying of catalogue date or any extracts from catalogues must have our consent in writing. Photographs and illustrations are Frilich productions. All rights to them are reserved and are subject to copyright.

We accept no responsibility for typographical or clerical errors in the catalogue. All dimensions given are approximate; we strictly reserve the right to make any alterations, without giving prior notice.